

Installation and Operating Guide | Warranty

Model Number | XBS341 | DVD+Hi-Fi VCR System
(Speakers: LHS-C6237T/LHS-C6237W)



Safety Precautions



CAUTION
RISK OF ELECTRIC SHOCK
DO NOT OPEN



CAUTION: TO REDUCE THE RISK OF ELECTRIC SHOCK DO NOT REMOVE COVER (OR BACK) NO USER-SERVICEABLE PARTS INSIDE REFER SERVICING TO QUALIFIED SERVICE PERSONNEL.



This lightning flash with arrowhead symbol within an equilateral triangle is intended to alert the user to the presence of uninsulated dangerous voltage within the product's enclosure that may be of sufficient magnitude to constitute a risk of electric shock to persons.



The exclamation point within an equilateral triangle is intended to alert the user to the presence of important operating and maintenance (servicing) instructions in the literature accompanying the product.

WARNING: TO REDUCE THE RISK OF FIRE OR ELECTRIC SHOCK, DO NOT EXPOSE THIS APPARATUS TO RAIN OR MOISTURE.

CAUTION: TO PREVENT ELECTRIC SHOCK, MATCH WIDE BLADE OF PLUG TO WIDE SLOT, FULLY INSERT.

ATTENTION: POUR ÉVITER LES CHOC ÉLECTRIQUES, INTRODUIRE LA LAME LA PLUS LARGE DE LA FICHE DANS LA BORNE CORRESPONDANTE DE LA PRISE ET POUSSER JUSQU'AU FOND.

WARNING: Do not install this equipment in a confined space such as a bookcase or similar unit.

NOTE TO CABLE/TV INSTALLER: This reminder is provided to call the cable TV system installer's attention to Article 820-40 of the National Electric Code (U.S.A.). The code provides guidelines for proper grounding and, in particular, specifies that the cable ground shall be connected to the grounding system of the building, as close to the point of the cable entry as practical.

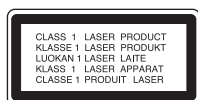

CAUTION:

This DVD+Hi-Fi VCR System employs a Laser System.

To ensure proper use of this product, please read this owner's manual carefully and retain for future reference. Should the unit require maintenance, contact an authorized service center see back page for instructions.

Use of controls, adjustments, or the performance of procedures other than those specified herein may result in hazardous radiation exposure.

To prevent direct exposure to laser beam, do not try to open the enclosure. Visible laser radiation when open. DO NOT STARE INTO BEAM.

CAUTION: The apparatus should not be exposed to water (dripping or splashing) and no objects filled with liquids, such as vases, should be placed on the apparatus.

FCC WARNING: This equipment may generate or use radio frequency energy. Changes or modifications to this equipment may cause harmful interference unless the modifications are expressly approved in the instruction manual. The user could lose the authority to operate this equipment if an unauthorized change or modification is made.

FCC COMPLIANCE: The responsible party for this product's compliance is:
Zenith Electronics Corporation, 2000 Millbrook Drive,
Lincolnshire, IL 60069, USA
Phone: 1-847-941-8000.

REGULATORY INFORMATION: FCC Part 15

This product has been tested and found to comply with the limits for a Class B digital device, pursuant to Part 15 of the FCC Rules. These limits are designed to provide reasonable protection against harmful interference when the product is operated in a residential installation. This product generates, uses, and can radiate radio frequency energy and, if not installed and used in accordance with the instruction manual, may cause harmful interference to radio communications. However, there is no guarantee that interference will not occur in a particular installation. If this product does cause harmful interference to radio or television reception, which can be determined by turning the product off and on, the user is encouraged to try to correct the interference by one or more of the following measures:

- Reorient or relocate the receiving antenna.
- Increase the separation between the product and receiver.
- Connect the product into an outlet on a circuit different from that to which the receiver is connected.
- Consult the dealer or an experienced radio/TV technician for help.

NOTES ON COPYRIGHTS:

It is forbidden by law to copy, broadcast, show, broadcast via cable, play in public, or rent copyrighted material without permission.

This product uses copyright protection developed by Macrovision. Copy protection signals are recorded on some discs. When recording and playing the pictures of these discs on a VCR, picture noise will appear.

This product incorporates copyright protection technology that is protected by method claims of certain U.S. patents and other intellectual property rights owned by Macrovision Corporation and other rights owners. Use of this copyright protection technology must be authorized by Macrovision Corporation, and is intended for home and other limited viewing uses only unless otherwise authorized by Macrovision Corporation. Reverse engineering or disassembly is prohibited.

SERIAL NUMBER: The serial number is found on the back of this unit. This number is unique to this unit and not available to others. You should record requested information here and retain this guide as a permanent record of your purchase.

Model No. _____

Serial No. _____



IMPORTANT SAFETY INSTRUCTIONS

CAUTION: PLEASE READ AND OBSERVE ALL WARNINGS AND INSTRUCTIONS IN THIS OWNER'S MANUAL. AND THOSE MARKED ON THE PRODUCT. RETAIN THIS MANUAL FOR FUTURE REFERENCE.

This product has been designed and manufactured to assure personal safety. Improper use can result in electric shock or fire hazard. The safeguards incorporated in this product will protect you if you observe the following procedures for installation, use, and servicing.



This product does not contain any parts that can be repaired by the user.

DO NOT REMOVE THE CABINET COVER, OR YOU MAY BE EXPOSED TO DANGEROUS VOLTAGE. REFER SERVICING TO QUALIFIED SERVICE PERSONNEL ONLY.

- 1. Read these instructions.** - All these safety and operating instructions should be read before the product is operated.
- 2. Keep these instructions.** - The safety, operating and use instructions should be retained for future reference.
- 3. Heed all warnings.** - All warnings on the product and in the operating instructions should be adhered to.
- 4. Follow all instructions.** - All operating and use instructions should be followed.
- 5. Do not use this product near water.** - For example: near a bath tub, wash bowl, kitchen sink, laundry tub, in a wet basement; or near a swimming pool; and other areas located near water.
- 6. Clean only with dry cloth.** - Unplug this product from the wall outlet before cleaning. Do not use liquid cleaners.
- 7. Do not block any ventilation openings. Install in accordance with the manufacturer's instructions.** - Slots and openings in the cabinet are provided for ventilation and to ensure reliable operation of the product and to protect it from over-heating. The openings should never be blocked by placing the product on a bed, sofa, rug or other similar surface. This product should not be placed in a built-in installation such as a bookcase or rack unless proper ventilation is provided or the manufacturer's instructions have been adhered to.
- 8. Do not install near any heat sources such as radiators, heat registers, stoves, or other apparatus (including amplifiers) that produce heat.**
- 9. Do not defeat the safety purpose of the polarized or grounding-type plug.** A polarized plug has two blades with one wider than the other. A grounding type plug has two blades and a third grounding prong. The wide blade or the third prong are provided for your safety. If the provided plug does not fit into your outlet, consult an electrician for replacement of the obsolete outlet.
- 10. Protect the power cord from being walked on or pinched particularly at plugs, convenience receptacles, and the point where they exit from the product.**
- 11. Only use attachments/accessories specified by the manufacturer.**
- 12. Use only with the cart, stand, tripod, bracket, or table specified by the manufacturer, or sold with apparatus. When a cart is used, use caution when moving the cart/product combination to avoid injury from tip-over.**
- 13. Unplug this product during lightning storms or when unused for long periods of time.**
- 14. Refer all servicing to qualified service personnel. Servicing is required when the product has been damaged in any way, such as power-supply cord or plug is damaged, liquid has been spilled or objects have fallen into the product, the product has been exposed to rain or moisture, does not operate normally, or has been dropped.**





Table of Contents

Introduction	
Safety Precautions	2
IMPORTANT SAFETY INSTRUCTIONS	3
Table of Contents	4
Before Use	5-6
Playable Discs	5
Precautions	6
Notes on Discs	6
About Symbols	6
Front Panel Controls	7
Display Window Indicators	8
Remote Control Buttons	9
Rear Panel Connections	10
Pre-operation Setup	
Connections	11-14
Connecting Antenna/Cable TV to DVD+Hi-Fi	
VCR System	11
Basic TV Connections	12
Accessory Audio/Video (A/V) Connections to	
DVD+Hi-Fi VCR System	13
Radio Antenna Connections	13
Speaker System Connections	14
Speaker Positions	14
Glossary for Audio Stream & Surround mode	15
VCR Pre-operation Setup	16-18
On-Screen Display (OSD)	16
On-Screen Menus Setup	16
VCR Setup Menu Options	17
Channel Selection	17
Setting the Clock	18
DVD pre-operation Setup	19-22
General Explanation	19
On-Screen Display	19
Initial Settings	20-22
• <i>General Operation</i>	20
• <i>Language</i>	20
• <i>Picture</i>	20
• <i>5.1 Speaker setup</i>	21
• <i>Others</i>	21
• <i>Parental Control</i>	22
Operation	
VCR Operation	23-28
Normal Playback	23
Special Effect Playbacks	23
• <i>Search</i>	23
• <i>Still Picture and Frame-by-Frame Playback</i>	23
• <i>Slow Motion</i>	23
• <i>CM Skip (Commercial Skip)</i>	23
Normal Recording	24
Timer Recording	24-25
Instant Timer Recording	26
Dubbing and Editing	26
Copying from DVD to VCR	26
VHS Hi-Fi Stereo System/MTS Broadcast	27
Tape Counter Memory Feature	28
Additional Information	28
DVD Operation	29-30
Playing DVDs	29
General Features	29
• <i>Changing TITLES</i>	29
• <i>Changing Chapters</i>	29
• <i>Slow Motion</i>	29
• <i>Still Picture and Frame-by-Frame Playback</i>	30
• <i>Search</i>	30
• <i>Repeat</i>	30
• <i>Repeat A-B</i>	30
• <i>Time Search</i>	30
• <i>3D Surround</i>	30
• <i>Zoom</i>	30
• <i>Marker Search</i>	31
Special DVD Features	31
• <i>Checking the contents of DVD Video discs: Menus</i>	31
• <i>Title Menu</i>	31
• <i>Disc Menu</i>	31
• <i>Camera Angle</i>	31
• <i>Changing the Audio Language</i>	31
• <i>Subtitles</i>	31
Audio CD or MP3/WMA Disc Operation	32-33
Playing Audio CDs or MP3/WMA Discs	32
Notes on MP3/WMA Recordings	32
• <i>Pause</i>	33
• <i>Changing Tracks</i>	33
• <i>Repeat Track/ All/ Off</i>	33
• <i>Search</i>	33
• <i>Repeat A-B</i>	33
• <i>3D Surround</i>	33
• <i>Changing the Audio Channel</i>	33
JPEG File Operation	34
Programmed Playback	35
Programmed Playback with Audio CDs	
and MP3/WMA Discs	35
• <i>Repeat Programmed Tracks</i>	35
• <i>Erasing a Track from the Program List</i>	35
• <i>Erasing the entire Program List</i>	35
Speaker Setup	36
Radio Operation	37-38
Presetting Radio Stations	37
Radio Operation	37
To Clear Stored Radio Stations	37
Tuning Stations Manually	38
Tuning Stations Automatically	38
Mute	38
Reference	
Troubleshooting	39-40
Language Code List	41
Country Code List	42
Specifications	43-44
Notes	45-46-47
About the symbols for instructions	
 Indicates hazards likely to cause harm to the unit itself or other material damage.	
 Indicates special operating features of this unit.	
 Indicates tips and hints for making the task easier.	
<i>Manufactured under license from Dolby Laboratories. "Dolby", "Pro Logic", and the double-D symbol are trademarks of Dolby Laboratories. Confidential Unpublished works. Copyright 1992-1997 Dolby Laboratories. All rights reserved.</i>	
<i>Manufactured under license from Digital Theater Systems, Inc. US Pat. No. 5,451,942 5,956,674, 5,974,380, 5,978,762 and other worldwide patents issued and pending. "DTS" and "DTS Digital Surround" are registered trademarks of Digital Theater Systems, Inc. Copyright 1996, 2000 Digital Theater Systems, Inc. All rights reserved.</i>	

Before Use

Playable Discs

	DVD video discs (8 cm / 12 cm disc)
	Audio CD (8 cm / 12 cm disc)

In addition, this unit can play the following: DVD-RW, DVD+RW, Kodak PICTURE CD, and CD-R or CD-RW discs that contain audio titles, MP3, or JPEG files.

Notes

- Depending on the conditions of the recording equipment or the CD-R/RW (or DVD-RW, DVD+RW) disc itself, some CD-R/RW (or DVD-RW, DVD+RW) discs cannot be played on the unit.
- Do not attach any seal or label to either side (the labeled side or the recorded side) of a disc.
- Do not use irregularly shaped CDs (e.g., heart-shaped or octagonal). Doing so may result in malfunctions.

Notes on DVDs

Some playback operations for DVDs may be intentionally fixed by software manufacturers. As this unit plays DVDs according to disc content designed by the software manufacturer, some playback features of the unit may not be available or other functions may be added. Make sure to also refer to the instructions supplied with the DVDs. Some DVDs made for business purposes may not be able to be played on the unit.

Regional code of the DVD+Hi-Fi VCR and DVDs

This DVD+Hi-Fi VCR is designed and manufactured for playback of Region “1” encoded DVD software. The region code on the labels of some DVDs indicates which type of DVD+Hi-Fi VCR can play those discs. This unit can only play DVDs labelled “1” or “ALL”. If you try to play any other discs, the message “Check Regional Code” will appear on the TV screen. Some DVDs that have no region code label may still be subject to area restrictions and therefore not playable.



IMPORTANT NOTE:

SPENT OR DISCHARGED BATTERIES MUST BE RECYCLED OR DISPOSED OF IN A SAFE MANNER IN COMPLIANCE WITH ALL APPLICABLE LAWS. FOR DETAILED INFORMATION, CONTACT YOUR LOCAL COUNTY SOLID WASTE AUTHORITY.

Disc-related terms

Title (DVD only)

The main film content or accompanying feature content or additional feature content, or music album.

Each title is assigned a title reference number enabling you to locate it easily.

Chapter (DVD only)

Sections of a picture or a musical piece that are smaller than titles.



A title is composed of one or several chapters. Each chapter is assigned a chapter number, enabling you to locate the chapter you want. Depending on the disc, no chapters may be recorded.

Track (Audio CD only)

Sections of a musical piece on an audio CD. Each track is assigned a track number, enabling you to locate the track you want.

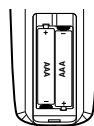
Remote Control Battery Installation



Detach the battery cover on the rear of the remote control, and insert two R03 (size AAA) batteries with  and  aligned correctly.

Caution

Do not mix old and new batteries. Never mix different types of batteries (standard, alkaline, etc.).

Remote Control Operating Range

Point the remote control at the remote sensor and press the buttons.

- **Distance:** About 23 ft (7 m) from the front of the remote sensor
- **Angle:** About 30° in each direction of the front of the remote sensor

Before Use (Continued)

Precautions

Handling the unit

Shipping the unit

The original shipping carton and packing materials come in handy. For maximum protection, re-pack the unit as it was originally packaged at the factory.

Setting up the unit

The picture and sound of a nearby TV, VCR, or radio may be distorted during playback. In this case, position the unit away from the TV, VCR, or radio, or turn off the unit after removing the disc.

Keeping unit surfaces clean

Do not use volatile liquids, such as insecticide spray, near the unit. Do not leave rubber or plastic products in contact with the unit for a long period of time. They will leave marks on the surface.

Cleaning the unit

Cleaning the cabinet

Use a soft, dry cloth. If the surfaces are extremely dirty, use a soft cloth lightly moistened with a mild detergent solution. Do not use strong solvents such as alcohol, benzene, or thinner, as these might damage the surface of the unit.

To obtain a clear picture

The DVD+Hi-Fi VCR is a high-tech, precision device. If the optical pick-up lens and disc drive parts are dirty or worn, the picture quality will be poor.

Regular inspection and maintenance are recommended after every 1,000 hours of use. (This depends on the operating environment.)

For details, please contact your nearest dealer.

Notes on Discs

Disc handling

Do not touch the playback side of the disc.

Hold the disc by the edges so that fingerprints will not get on the surface.

Do not stick paper or tape on the disc.



Storing discs

After playing, store the disc in its case.

Do not expose the disc to direct sunlight or sources of heat, or leave it in a parked car exposed to direct sunlight, as there may be a considerable temperature increase inside the car.

Cleaning discs

Fingerprints and dust on the disc can cause poor picture quality and sound distortion. Before playing, clean the disc with a clean cloth. Wipe the disc from the center outward.

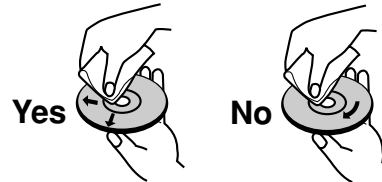

Do not use strong solvents such as alcohol, benzene, thinner, commercially available cleaners, or anti-static spray intended for older vinyl records.





Disc Symbols

About the symbol display

 may appear on the TV screen during operation. This icon means the function explained in this owner's manual is not available on that specific DVD video disc.

About the disc symbols on manual pages

A section whose title has one of the following symbols are applicable only to those discs represented by the symbol.

-  DVD
-  Audio CDs.
-  MP3 disc
-  WMA disc.
-  JPEG disc

Selecting Viewing Sources

You must select one of your output sources (DVD or VCR) to view on the TV screen.

• If you want to view DVD deck output source:

Press CD/DVD on the remote or DVD/VCR on the front panel until DVD indicator in the display window lights and output source of DVD deck is viewed on the TV screen.

• If you want to view VCR deck output source:

Press VCR on the remote or DVD/VCR on the front panel until VCR indicator in the display window lights and output source of VCR deck is viewed on the TV screen.

Notes

- If you insert a disc while the DVD+Hi-Fi VCR System is in the VCR mode, the DVD+Hi-Fi VCR System will switch to DVD mode automatically.
- If you insert a cassette tape without prevention tab while the DVD+Hi-Fi VCR System is in the DVD mode, the DVD+Hi-Fi VCR System will switch to VCR mode automatically.

Front Panel Control Functions

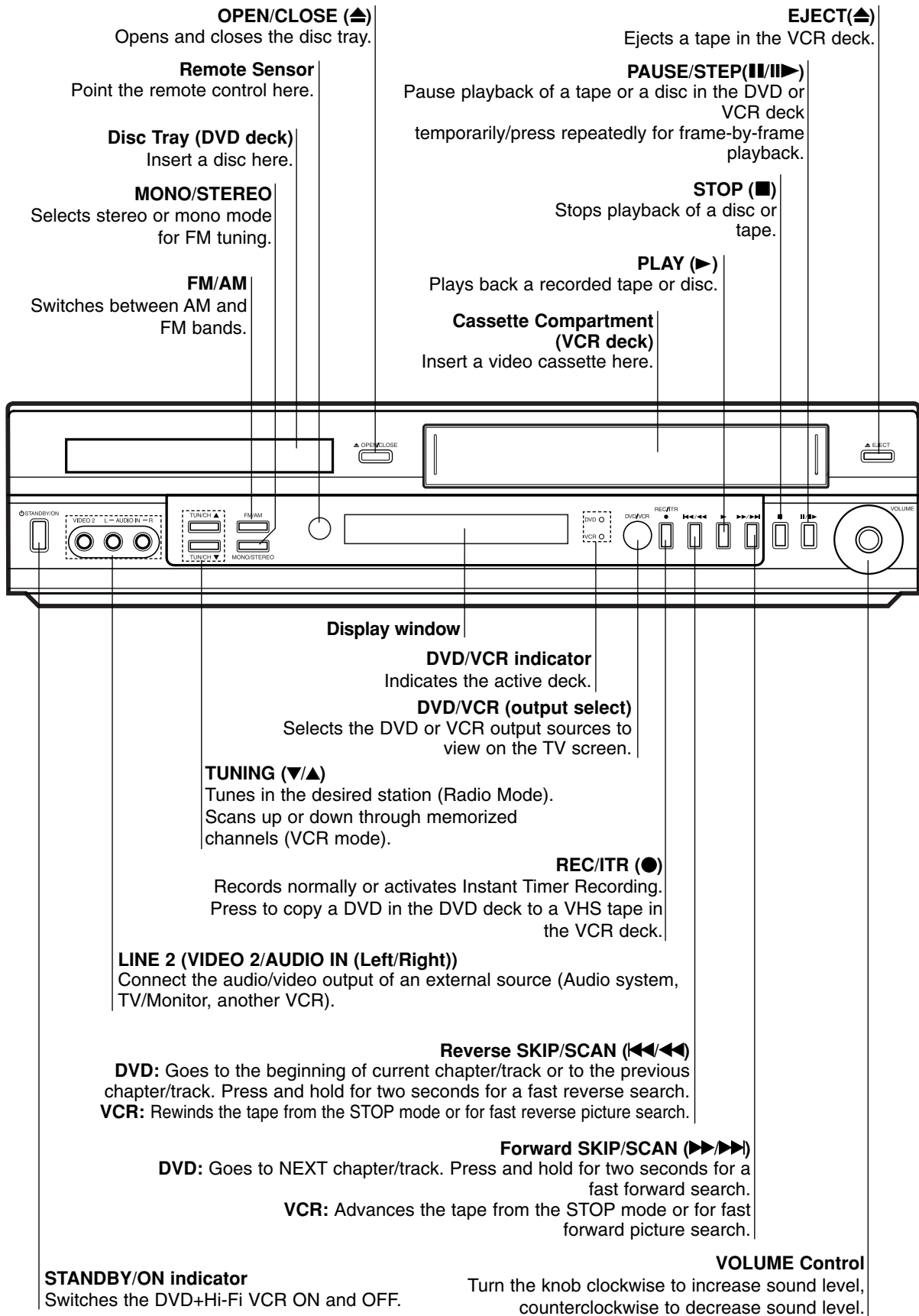

Display Window Indicators

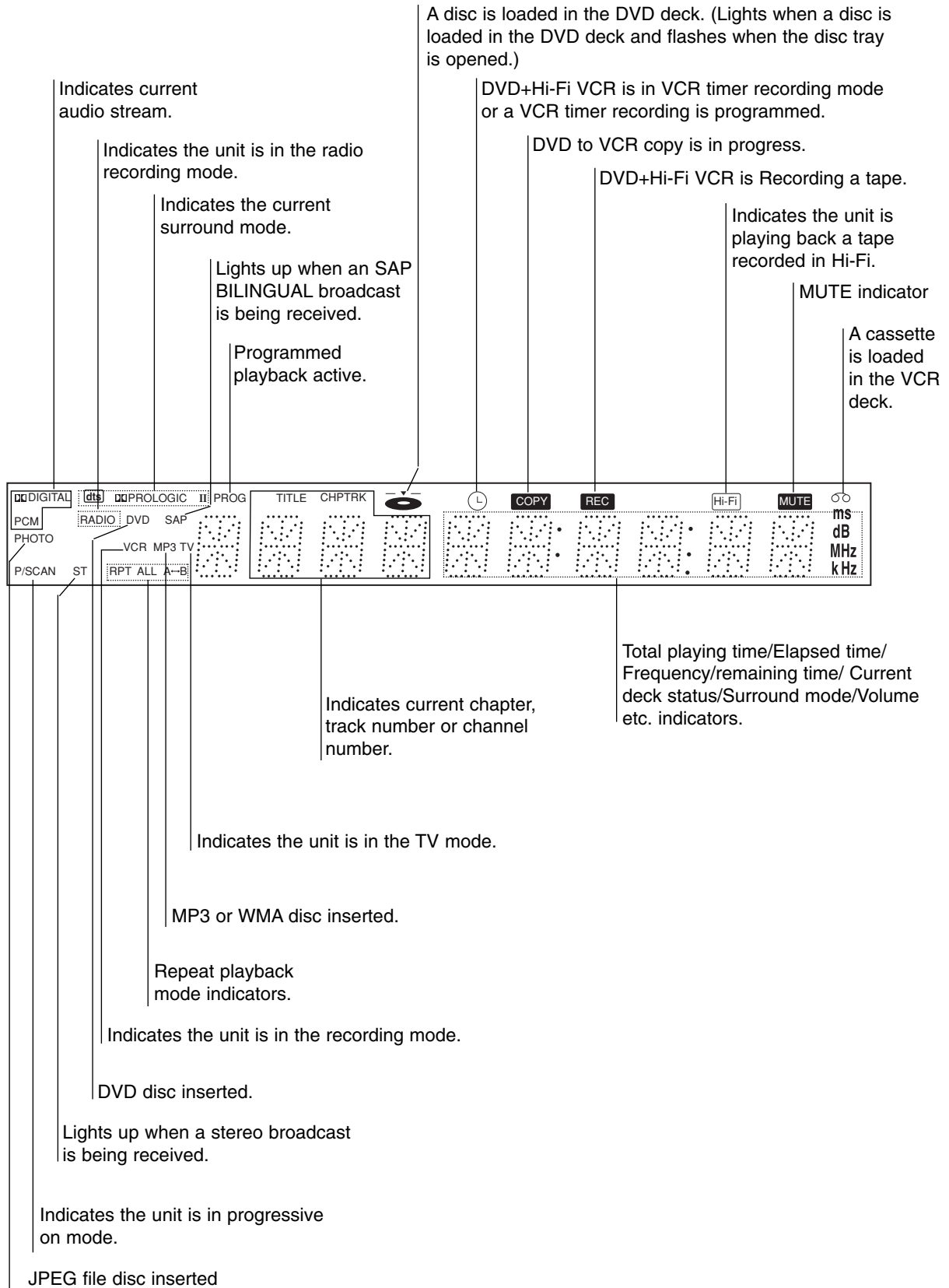

Remote Control Button Functions

- FM/AM Tuner select**
Select FM or AM band as the listening choice. (FM and AM bands)
- OPEN/CLOSE, EJECT (▲)**
- Opens and closes the disc tray.
- Ejects a tape in the VCR deck.
- CD/DVD/VCR select**
Selects the output source (CD/DVD or VCR) to view on the TV screen.
- 0-9 Number Keypad**
Selects numbered options in a menu.
- ANGLE**
Selects a DVD camera angles if available.
- PROGRAM**
Accesses or removes Program menu.
- ZOOM**
Enlarges DVD video image.
- MARKER**
Marks any point during playback.
- SEARCH**
Displays MARKER SEARCH menu.
- DISPLAY, CLK/CNT**
Accesses On-Screen display.
Switches between the clock, tape counter and tape remaining modes on the display.
- ◀/▶/▲/▼ (left/right/up/down)**
- Select menu options.
- **CH/TRK/PRESET (▲/▼):**
Selects VCR or Tuner channels.
Manually adjust the tape's picture onscreen.
- **TUNING (◀/▶):**
Tunes in the desired station.
- RETURN**
Removes the Setup menu.
- CM SKIP**
Fast forwards picture search through 30 seconds of recording.
- STOP (■)**
Stops playback.
- REC/ITR (●)**
Records normally or activates Instant Timer Recording.
- REPEAT/A-B/SPEED**
- Repeat chapter, track, title, all.
- Repeats sequence.
- Selects recording speed.
- TV/VCR**
Switch to view channels selected by the VCR tuner or by the TV tuner.

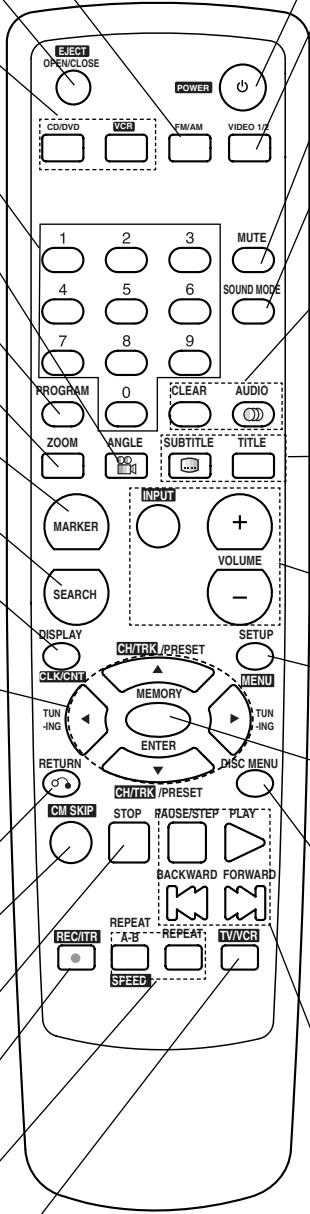

- POWER**
Switches DVD+Hi-Fi VCR ON and OFF.
- VIDEO 1/2**
Select input source.
- MUTE**
Turns the sound on and off temporarily.
- SOUND MODE**
Selects sound mode.
- CLEAR**
Removes a track number on the program menu or a mark on the MARKER SEARCH menu.
Clears preset stations from the tuner memory.
- AUDIO**
Selects an audio language (DVD) or an audio channel (CD).
 - **SUBTITLE**
Selects a subtitle language.
 - **TITLE**
Displays the disc's Title menu, if available.
 - **INPUT**
Selects the VCR deck's source (Tuner, LINE 1, or LINE 2).
 - **VOLUME (+/-)**
Adjusts speaker sound.
- SETUP, MENU**
Accesses or removes DVD Setup menu and VCR menu.
- MEMORY/ENTER**
 - Acknowledges menu selection.
 - Displays functions on the TV screen.
 - Stores a radio station's frequency in the tuner's memory.
- DISC MENU**
Accesses menu on a DVD disc.
 - **PAUSE/STEP (II/II▶)**
Pause playback or recording temporarily/press repeatedly for frame-by-frame playback.
 - **PLAY (▶)**
Starts playback.
 - **BACKWARD (◀◀)**
DVD: Search backward*/go to beginning of current chapter or track or go to previous chapter or track.
VCR: Rewinds the tape from STOP mode or for fast reverse picture search.
* Press and hold button for about two seconds.
 - **FORWARD (▶▶)**
DVD: Search forward*/go to next chapter or track.
VCR: Advances the tape from STOP mode or for fast forward picture search.

Note

This remote control use the same buttons for VCR and DVD functions (ex. PLAY). To use the VCR, first press the VCR button. To use the DVD, first press the CD/DVD button.

Rear Panel Connections

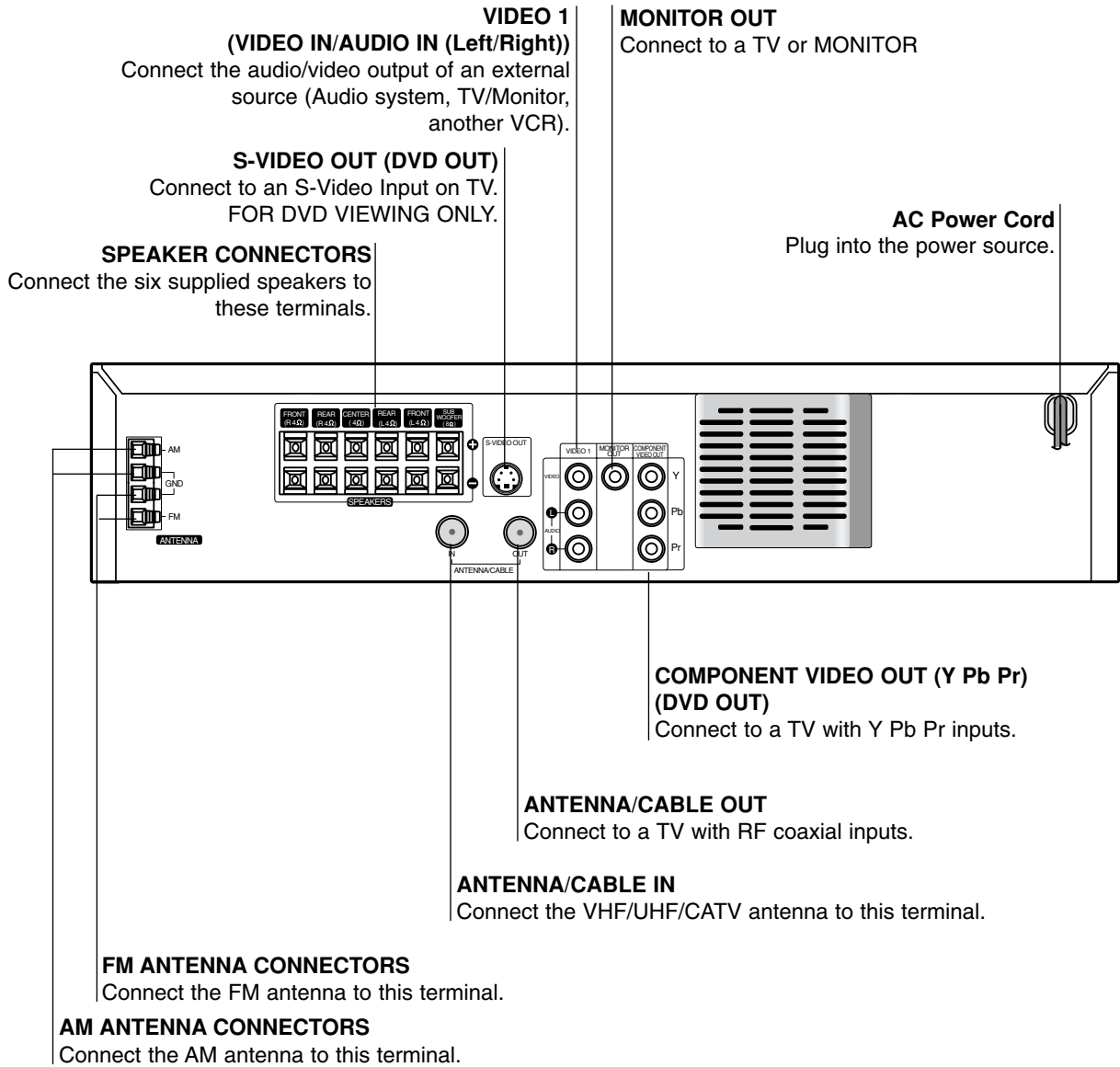

Do not touch the inner pins of the jacks on the rear panel. Electrostatic discharge may cause permanent damage to the unit.

Connections

Tips

- Depending on your TV and other equipment you wish to connect, there are various ways to connect the DVD+Hi-Fi VCR. Use connections described on pages 11-13.
- Please refer to the manuals of your TV, VCR, Stereo System or other devices as necessary to make the best connections.

Caution

- Make sure the DVD+Hi-Fi VCR is connected directly to the TV. Tune the TV to the correct video input channel.
- Do not connect your DVD+Hi-Fi VCR via your VCR. The DVD image could be distorted by the copy protection system.

Connecting Antenna/Cable TV to DVD+Hi-Fi VCR

- 1 Disconnect the antenna leads from the rear of the TV.
- 2 Identify the type of cable from your antenna. If it is a round cable as illustrated, it is a 75 ohm coaxial antenna cable. This cable will connect directly to the jack marked ANTENNA/CABLE IN on your DVD+Hi-Fi VCR.

Tip

If your antenna lead wire is a flat type antenna cable, connect it to an Antenna Adapter (300-ohm to 75-ohm) (not supplied) and slip the Adapter onto the ANTENNA/CABLE IN jack. The Adapter does not screw on to the DVD+Hi-Fi VCR, it just slips over the jack.

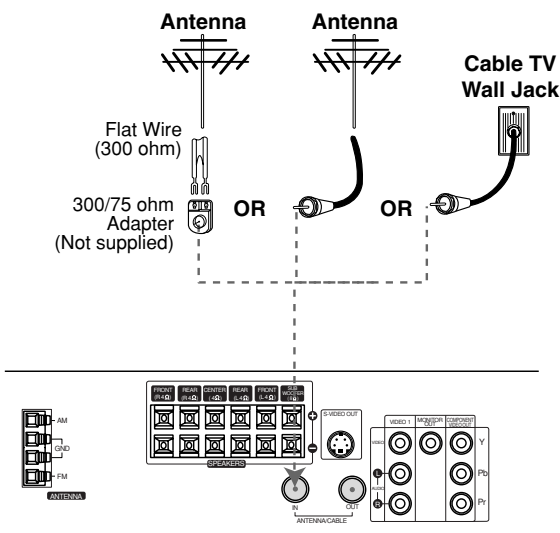

Note

- During DVD or VCR playback, THE DVD+Hi-Fi VCR is designed so that sound will be heard only from the unit's 5 speakers and subwoofer, (no sound output is provided to the TV if it is connected to the S-VIDEO OUT or MONITOR OUT on the unit with a optional cables.

Without Cable Box

If your cable wire is connected to your TV without a converter or descrambler box, unscrew the wire from your TV and attach it to the ANTENNA/CABLE IN jack on the DVD+Hi-Fi VCR. Use the supplied round coaxial cable to connect between the DVD+Hi-Fi VCR's ANTENNA/CABLE OUT jack and the 75 ohm antenna input jack on the TV. With this connection, you can receive all midband, super band, and hyperband channels.

With Cable Box

If a converter is required in your cable system, follow the instruction below:
The cable hookup permits both TV and DVD+Hi-Fi VCR operation.

To view or record CATV channel

- 1 Tune the TV to the DVD+Hi-Fi VCR output channel (CH 3 or 4).
- 2 Set the DVD+Hi-Fi VCR channel selector to the output channel of the Cable Converter box by using the CH/TRK (▲/▼) of your DVD+Hi-Fi VCR. (Example: CH3)
- 3 Select the channel to view at the Cable Converter Box.

Notes

- With this connection, you CANNOT record one program while viewing another.
- If you are using a cable box to tune channels, it is not necessary to do Auto Channel Programming as indicated on page 17.

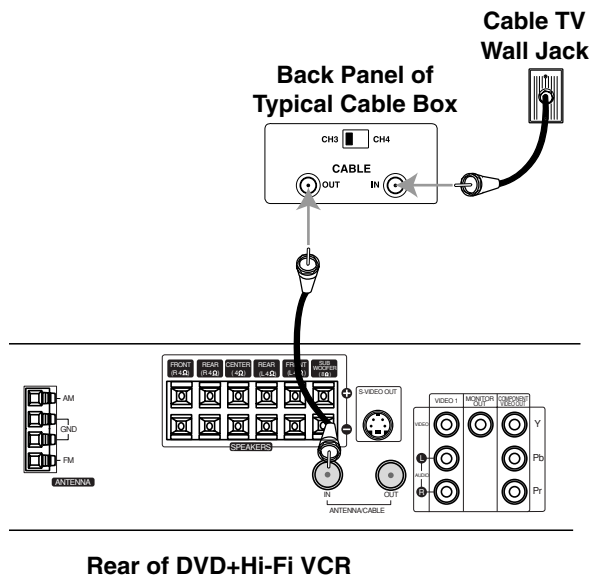

Connections (Continued)

Basic TV Connections

- Make one of the following connections, depending on the capabilities of your existing equipment.

RF coaxial connection

Connect the ANTENNA/CABLE OUT jack on the DVD+Hi-Fi VCR to the ANTENNA IN jack on the TV using the 75-ohm Coaxial Cable supplied (R).

Note

If you use this connection, tune the TV to the DVD+Hi-Fi VCR's RF output channel (CH 3 or 4).

How to set the DVD+Hi-Fi VCR's RF output channel

1. While the DVD+Hi-Fi VCR is turned off, press and hold TUNING (▲/▼) on the front panel for about five seconds.

The unit will turn itself on and "RF-03" or "RF-04" appears in the display window.

2. Use TUNING (▲/▼) on the front panel to change the RF output channel (CH 03 or CH 04).
3. Turn the DVD+Hi-Fi VCR off and then on.
4. Select the TV's CH to 3 or 4 depending on the RF output channel you had selected.
Now you can watch the DVD+Hi-Fi VCR playback on CH3 or CH4 of your TV.

Video connection

Connect the MONITOR OUT jack on the DVD+Hi-Fi VCR to the VIDEO IN jack on the TV using the video cable supplied (V).

Notes

- If you use this connection, set the TV's source selector to VIDEO.

S-Video connection

Connect the S-VIDEO OUT jack on the DVD+Hi-Fi VCR to the S-VIDEO IN jack on the TV using the optional S-Video cable (S).

Component Video (Color Stream®) connection

Connect the COMPONENT VIDEO OUT jacks on the DVD+Hi-Fi VCR to the corresponding IN jacks on the TV using a Y Pb Pr cable (C).

Progressive Scan (ColorStream® pro) connection

- If your television is a high-definition or "digital ready" television, you may take advantage of the DVD+Hi-Fi VCR's progressive scan output for the highest video resolution possible.
- If your TV does not accept the Progressive Scan format, the picture will appear scrambled if you try Progressive Scan on the DVD+Hi-Fi VCR.

Connect the COMPONENT VIDEO OUT jacks on the DVD+Hi-Fi VCR to the corresponding IN jacks on the TV using an optional Y Pb Pr cable (C).

Note

- Set the Progressive option to "On" in the Setup menu for a progressive signal, see page 20.

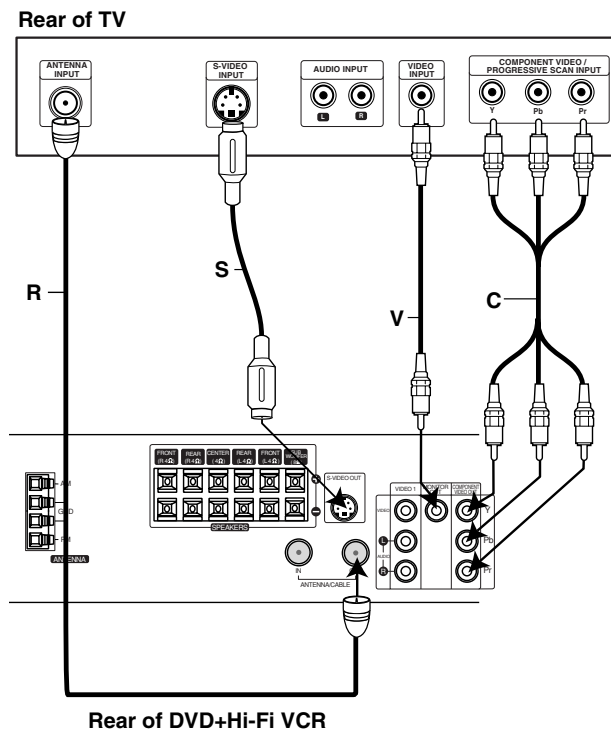

Connections (Continued)

Accessory Audio/Video (A/V) Connections to DVD+Hi-Fi VCR

Connect the VIDEO 1 or VIDEO 2 jacks on the DVD+Hi-Fi VCR to the AUDIO/VIDEO OUT jacks on your accessory component, using the optional audio/video cables.

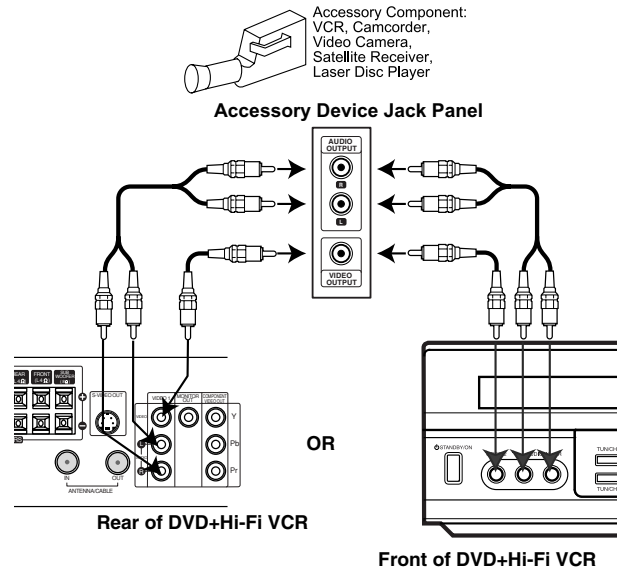

Radio Antenna Connections

Connect the supplied FM/AM antennas for listening to the radio.

- Connect the AM loop antenna to the AM antenna connector.
- Connect the FM wire antenna to the FM antenna connector.

Notes

- To prevent noise pickup, keep the AM loop antenna away from the DVD+Hi-Fi VCR and other components.
- Be sure to fully extend the FM wire antenna.
- After connecting the FM wire antenna, keep it as horizontal as possible.

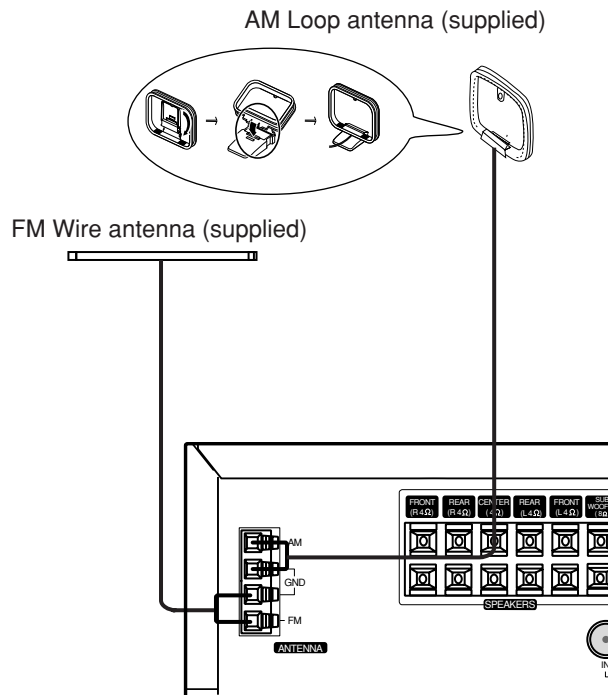

Connections (Continued)

Speaker System Connections

Connect the speakers using the supplied speaker cords.

To obtain the best possible surround sound, adjust the speaker parameters; distance, level, etc..

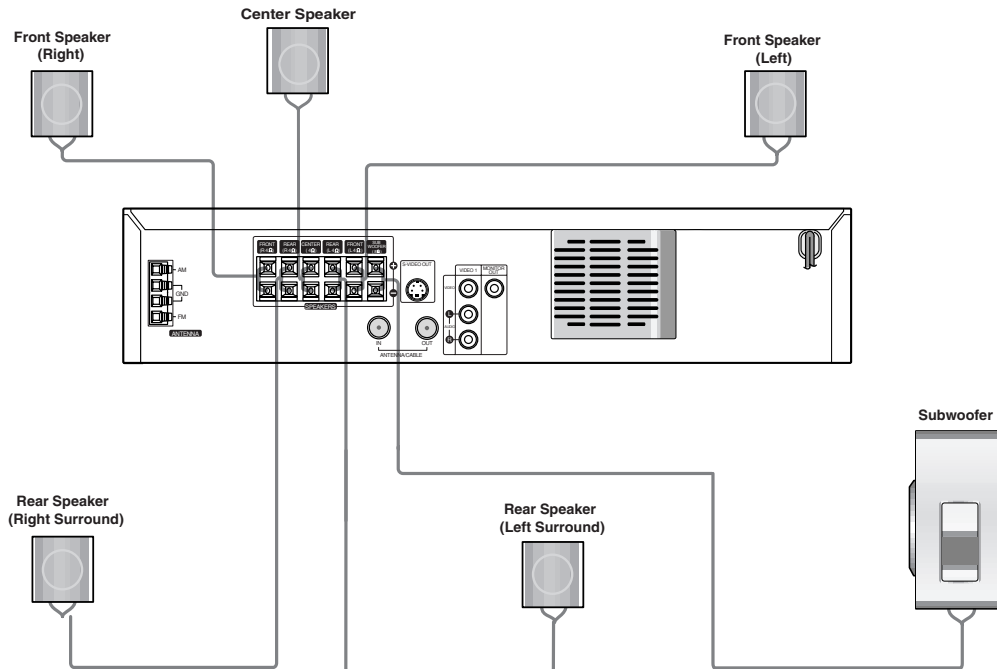

Notes

- Be sure to match the speaker cable to the appropriate terminal on the connectors: + to + and - to -. If the cables are reversed, the sound will be distorted and will lack bass.
- When making the sound louder, adjust the sound level carefully to avoid excessive volume output to the speakers.
- Only 2-channel stereo (Front Left, Front Right & Subwoofer) is available in VCR mode, thus sound might not be heard from center or rear speakers during VCR playback. (For further details about sound mode, please refer to next page.)
- Do not remove the front covers of supplied speakers.

Speaker Positioning

For a normal setup, use 6 speakers (2 front speakers, center speaker, 2 rear speakers and subwoofer).

If you want to hear excellent bass sound or Dolby Digital surround, you should connect a subwoofer.

- **Front speakers**
From your listening position, place the speakers an equal distance away and with an interval of 45 degrees between speakers.
- **Center speaker**
It is ideal if the center speakers and front speakers are at the same height. You would normally place the center speaker above or below television as shown.
- **Rear speakers**
Place left and right behind the listening area. These speakers recreate sound motion and atmosphere required for surround sound playback. For best results, do not install the rear speakers too far behind the listening position and install them at or above the level of the listener's ears. It is also effective to direct the rear speakers towards a wall or ceiling to further disperse the sound.
For smaller room size, if the audience is near to the rear wall, place the rear speakers opposite each other, and 24 - 36 inches above the listeners' ears.
- **Subwoofer**
This can be placed in any front position.

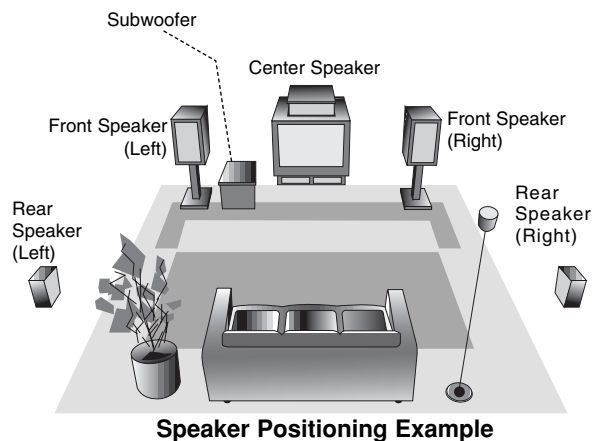

Speaker Positioning Example

Glossary for Audio Stream & Surround mode

dts

Allows you to enjoy 5.1(or 6) discrete channels of high quality digital audio from DTS program sources such as discs, DVD and compact discs, etc. bearing the trademark. DTS Digital Surround delivers up to 6 channels of transparent audio and results in exceptional clarity throughout a true 360 degree sound field. The term DTS is a trademark of DTS Technology, LLC. Manufactured under license from DTS Technology, LLC.

DOLBY DIGITAL

The Dolby Digital surround format lets you enjoy up to 5.1 channels of digital surround sound from a Dolby Digital program source. If you play DVDs with “” mark, you can enjoy even better sound quality, greater spatial accuracy, and improved dynamic range.

DOLBY PRO LOGIC

Use this mode when playing movie or Dolby Digital 2 channel which carries the “” mark. This mode provides the effect of being in a movie theatre or live concert house-an effect with an intensity which can only be obtained through DOLBY PRO LOGIC SURROUND. The effect of the front/back/left/right movement of the sound image, as well as the sense of fixed position in the sound image, is much clearer and more dynamic than before.

DOLBY PRO LOGIC (II)

Dolby Pro Logic II creates five full-bandwidth output channels from two-channel sources. This is done using an advanced, high-purity matrix surround decoder that extracts the spatial properties of the original recording without adding any new sounds or tonal colorations.

MOVIE mode:

The Movie mode is for use with stereo television shows and all programs encoded in Dolby Surround. The result is enhanced soundfield directionality that approaches the quality of discrete 5.1-channel sound.

MUSIC mode:

The Music mode is for use with any stereo music recordings.

MATRIX mode:

The Matrix mode is the same as the Music mode except that the directional enhancement logic is turned off. It may be used to enhance mono signals by making them seem “larger.” The Matrix mode may also find use in auto systems, where the fluctuations from poor FM stereo reception can otherwise cause disturbing surround signals from a logic decoder. The ultimate “cure” for poor FM stereo reception may be simply to force the audio to mono.

3D SURROUND

This unit can produce a 3D Surround effect, using 3D Surround Sound technology, which simulates multi-channel audio playback from two conventional stereo speakers instead of the five or more speakers normally required to listen to multi-channel audio from a home theatre. This feature works with DVD discs encoded with Dolby Pro Logic and Dolby Digital audio tracks.

BYPASS

Software with multichannel surround audio signals is played according to the way it was recorded.

Sound Mode

You can enjoy surround sound simply by selecting one of the pre-programmed sound fields according to the program you want to listen to.

Each time you press the **SOUND MODE** button, the sound mode is changed in the following order;

PRO LOGIC → PLII MOVIE → PLII MUSIC → PLII MATRIX → 3D SURROUND → BYPASS ...

For DVD Operation

You can change the sound mode of DVD (Dolby Digital, DTS, PRO LOGIC, etc.) by pressing the **AUDIO** button repeatedly on the remote during playback.



Although DVD contents differ from disc to disc, the following explains the basic operation when this feature is used.

Each time you press **AUDIO**, the DVD+Hi-Fi VCR sound mode is changed in the following order;

DOLBY DIGITAL → **dts** → **PCM** → **DOLBY DIGITAL**



For your reference

- The DVD/CD Receiver memorizes the last mode setting for each source individually.
- You can identify the encoding format of program software by looking at its packaging.
 - Dolby Digital discs are labeled with the  logo.
 - Dolby Surround encoded programs are labeled with the  logo.
 - DTS Digital Surround discs are marked with DTS.

Notes

- When you play sound tracks with 96kHz sampling frequency, the output signals will be converted to 48kHz (sampling frequency).
- Sound Mode is not applicable when headphones are used.

VCR Operation Setup

On-Screen Display (OSD)

Some of these functions appear during VCR operated.

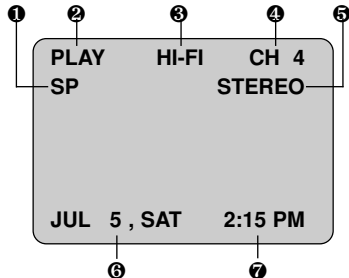

1 TAPE SPEED DISPLAY

Shows the current tape speed.

2 FUNCTION DISPLAY

Indicates the function in progress.

3 HI-FI DISPLAY

Indicates the unit is playing back tape recorded in Hi-Fi.

4 CHANNEL DISPLAY

Indicates the selected channel (or LINE1, LINE2).

5 STEREO/SAP DISPLAY (MONO is not displayed)

Shows the type of audio signal received by the VCR tuner.

6 DATE DISPLAY

Shows the current date. (Month/Date/Day of the week format)

7 CLOCK/COUNT/REMAIN DISPLAY

Shows the current time, the tape counter and remaining time on the tape.

Each press of **MEMORY/ENTER** changes the TV on-screen displays in the following sequence.

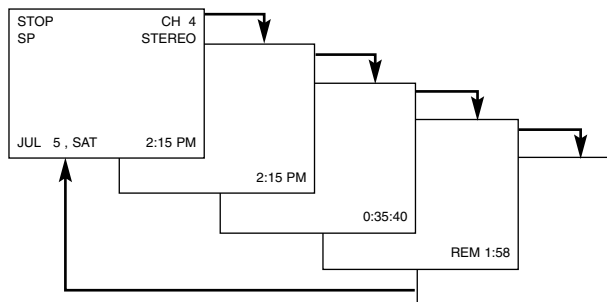

Notes

- The function displays remain on the TV screen for 5 seconds.
- The clock (or tape counter, tape remaining) mode will continue to be shown until you press **MEMORY/ENTER**.
- The tape counter and the remaining tape length indicator appear only when a cassette is inserted. Also, the remaining tape length indicator appears after any tape operation.

EASY INFORMATION

If the Extended Data Service (XDS) signals are provided along with normal TV signal in your area or during playback of a tape recorded with Extended Data Service (XDS) signals, the station ID, program title, and program details are shown on the TV screen.

When viewing a channel with Extended Data Service (XDS) signals, press **MEMORY/ENTER** and the station ID will appear on the TV screen. Press **MEMORY/ENTER** again and the program details will appear on the TV screen.

When viewing a tape recorded with Extended Data Service (XDS) signals, press **MEMORY/ENTER** twice and the program title and program details will appear on the TV screen.

PROGRAM DETAILS

LENGTH: Indicates the run length of a program.

TIME REMAINING: Indicates the remaining time of a program.

RATING: Indicates the rating of the current program (N/A, G, PG, PG-13, R, NC-17, X and Not Rated). The rating N/A means that the motion picture ratings are not applicable to this program.

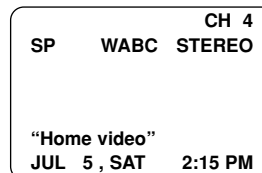

Easy Information Screen (Station ID)

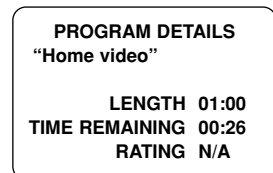

Easy Information Screen (Program details)

On-Screen Menu Setup

The **SETUP**, clock setting (**CLOCK**), and timer recordings (**PROGRAM**) functions are accessed conveniently with the on-screen menus, that lead you through each step. The following pages describe the on-screen menu selections available.

Menu Selection

Your VCR allows remote control adjustment of several features.

1 Press **MENU** and the **MAIN** menu will appear.

2 Select the desired menu with **▲/▼** button and then press **MEMORY/ENTER**.

Note

Menus remain on-screen for 3 minutes.

MAIN MENU

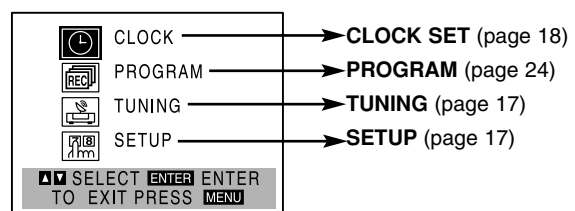

3 Press **MENU** when finished.

VCR Operation Setup (Continued)

VCR Setup Menu Options

- 1 Press **MENU** and the **MAIN** menu will appear.
- 2 Use **▲/▼** to select the **SETUP** menu, then press **MEMORY/ENTER**.
The **SETUP** menu will appear.

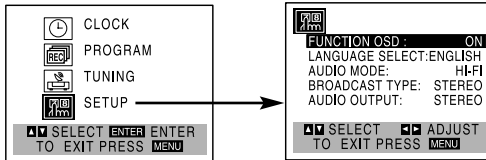

- 3 Use **▲/▼** to choose a desired option on the **SETUP** menu. Then use **◀/▶** to choose a desired setting.

FUNCTION OSD

The on-screen display of this DVD+Hi-Fi VCR can be turned on or off.

- **FUNCTION OSD:** Choose **ON** and **OFF** with **◀/▶**.

LANGUAGE SELECT

The on-screen programming of this DVD+Hi-Fi VCR can be displayed in either English, Spanish, or French.

- **LANGUAGE SELECT:** Choose **ENGLISH**, **SPANISH**, or **FRENCH** with **◀/▶**.

AUDIO MODE

The DVD+Hi-Fi VCR has two separate audio playback systems, the high quality VHS Hi-Fi system and standard NORMAL mono system. The same audio is generally recorded on both systems. The VHS Hi-Fi system plays on separate (left and right) channels, and the NORMAL system plays monaural sound. The normal track is always played so the cassette can be played on a DVD+Hi-Fi VCR that does not have VHS Hi-Fi.

- **AUDIO MODE:** Choose **Hi-Fi** or **NORMAL** with **◀/▶**.

BROADCAST TYPE (STEREO/SAP/MONO)

Multichannel Television Sound (MTS) carries stereo and/or Second Audio Program (SAP) bilingual signals. Set this display to the desired position when both MTS stereo and SAP signals are received. When only one of the MTS signal is received, the DVD+Hi-Fi VCR automatically selects the corresponding receiving mode (Stereo or SAP) regardless of the selected position. For normal operation, the display should be in the **STEREO** position. The DVD+Hi-Fi VCR will then record a **STEREO** program when available, and record a **mono** program IF the program is **NOT IN STEREO**. For weak **STEREO** and/or **SAP** broadcasts, changing the display to **mono** may give clearer sound.

- **BROADCAST TYPE:** Choose **STEREO**, **SAP**, or **MONO** with **◀/▶**.

AUDIO OUTPUT (STEREO/LEFT/RIGHT)

Used during playback [when **AUDIO MODE** (**HI-FI**/**NORMAL**) is in **HI-FI** position] for selecting the audio output signals from the **AUDIO OUT** terminals (**L ch** and **R ch**), and **RF. OUT**.

This display setting should normally be left in the **stereo** position, so that when a stereo tape is played, the stereo sound will be heard through the left and right channels. If a mono tape is played and the audio output is set to **stereo**, the same mono sound will be heard from both left and right channels.

- **AUDIO OUTPUT:** Choose **STEREO**, **LEFT**, or **RIGHT** with **◀/▶**.

- 4 Press **MENU** when finished.

Channel Selection

This DVD+VCR is equipped with a frequency synthesized tuner capable of receiving up to 181 channels. These include VHF channels 2-13, UHF channels 14-69 and CATV channels 1-125.

Preparation:

- Connect the DVD+Hi-Fi VCR to the desired type of antenna or cable TV system, as shown in **Connecting Antenna/Cable TV to DVD+Hi-Fi VCR** on page 11.

AUTO CHANNEL PROGRAMMING

- 1 Press **MENU** and the **MAIN** menu will appear.
- 2 Use **▲/▼** to select the **TUNING** menu, then press **MEMORY/ENTER**.
The **TUNING** menu will appear.

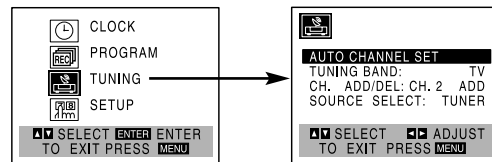

- 3 Use **▼** to choose the **SOURCE SELECT** option, then use **◀/▶** to select **TUNER**.
Press **◀/▶** repeatedly to switch among **TUNER**, **LINE1** or **LINE2**.
- 4 Use **▲/▼** to choose the **AUTO CHANNEL SET** option, then use **◀/▶** to search for channels.
The tuner will automatically cycle through all available channels in the area and place them in the tuner's memory.
- 5 After the **AUTO CHANNEL SET** proceeding is complete, make sure the **TUNING BAND** is set appropriately (**TV** or **CATV**). Choose the correct **TUNING BAND** (**TV** or **CATV**) with **◀/▶** while in the **TUNING** menu.
Remember, **TV** is for the air antenna reception, **CATV** is for cable or wireless cable connection.
- 6 Press **MENU** to return to the **TV** screen.
- 7 Use **TUNING** (**▲/▼**) on the front panel or **CH/TRK** (**▲/▼**) on the remote control to cycle the DVD+Hi-Fi VCR through the channels in memory.

TO ADD OR ERASE CHANNELS FROM MEMORY

This feature allows you to add or erase channels from memory manually.

- 1 Use **▼** to choose the **CH. ADD/DEL** option on the **TUNING** menu. Use **◀/▶** to select a channel to add or erase.
- 2 Use **MEMORY/ENTER** to add or erase the channel. Repeat steps 1 and 2 to add or erase channels.
- 3 Press **MENU** to remove menu.

VCR Operation Setup (Continued)

Setting the Clock

The DVD+Hi-Fi VCR gives you two ways to set the time and date: the Auto Clock Feature or manually. The Auto Clock feature enables the DVD+Hi-Fi VCR to set up the clock while the DVD+Hi-Fi VCR is turned off.

Things to know before starting

- The clock uses the 12-hour system. (Be sure to set AM and PM correctly.) (AM does not appear.)
- The initial Clock Setting is **JANUARY 1, 2003, 12:00 AM**.

Auto Clock Set

The Auto Clock Set feature is set to ON at the factory. In the ON setting, the DVD+Hi-Fi VCR looks for a channel carrying XDS (Extended Data Services) information. XDS updates the clock using the Coordinated Universal Time.

The Auto Clock feature enables the DVD+Hi-Fi VCR to set up the clock while the DVD+Hi-Fi VCR is turned off.

- 1 Press **MENU** and the MAIN menu will appear.
- 2 Use **▲/▼** to choose the **CLOCK** menu. Press **MEMORY/ENTER** and the **CLOCK** menu will appear.

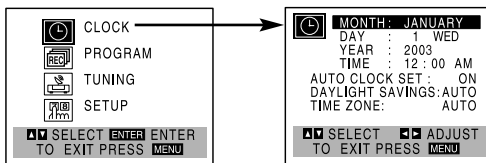

- 3 Use **▼** to choose the **AUTO CLOCK SET** option. Use **◀/▶** to choose **ON**.

The Auto Clock Set feature is set to ON at the factory. In the ON setting, the DVD+VCR looks for a channel carrying XDS (Extended Data Services) information. XDS updates the clock using the Coordinated Universal Time.

- 4 Use **▼** to choose the **DAYLIGHT SAVINGS** option.

Use **◀** or **▶** to choose **AUTO, ON, or OFF**.

If you choose **AUTO**, the VCR sets the clock using the DST information broadcast in the signal (channel). If you choose **ON**, the VCR adjusts the clock for Daylight Saving Time automatically.

- 5 Use **▼** to choose the **TIME ZONE** option. Use **◀** or **▶** to choose the correct time zone (**AUTO, EASTERN, CENTRAL, MOUNTAIN, PACIFIC, ALASKA or HAWAII**).

If "AUTO" is selected as the time zone, the VCR sets the clock using the first Coordinated Universal Time information it finds in a broadcast signal.

- 6 Press **MENU** when finished.

- 7 Turn off the DVD+Hi-Fi VCR and the auto clock set feature sets the time.

Note

There are cases where the TV station does not send or sends wrong date and/or time information and the DVD+Hi-Fi VCR sets the incorrect time.

If this happens we recommend that you set the clock manually.

Manual Clock Set

- 1 Press **MENU** and the MAIN menu will appear.
- 2 Use **▲/▼** to choose the **CLOCK** menu. Press **MEMORY/ENTER** and the **CLOCK** menu will appear.

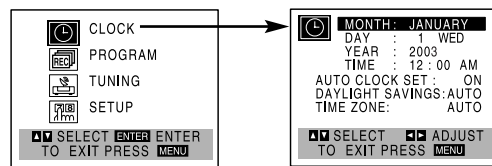

- 3 Use **◀/▶** to choose the month.
- 4 Use **▼** to choose the **DAY** option. Use **◀/▶** to choose the date. The day of the week will display automatically.
- 5 Use **▼** to choose the **YEAR** option. Use **◀/▶** to choose the year.
- 6 Use **▼** to choose the **TIME** option. Use **◀/▶** to choose the time. Press and hold **◀/▶** to advance clock continuously.
- 7 Use **▼** to choose the **DAYLIGHT SAVINGS** option. Use **◀** or **▶** to choose **AUTO, ON, or OFF**. If you choose **AUTO**, the VCR sets the clock using the DST information broadcast in the signal (channel). If you choose **ON**, the VCR adjusts the clock for Daylight Saving Time automatically.



- 8 Press **MENU** when finished.

Note

If setting the clock manually, "**AUTO CLOCK SET**" must set to "**OFF**".

If set to "**ON**", an incorrect date and/or time will be entered again when the DVD+Hi-Fi VCR is turned off.

DVD Operation Setup



General Explanation



This manual gives basic instructions for operating the DVD+Hi-Fi VCR. Some DVDs require specific operation or allow only limited operation during playback. When this occurs, the symbol  appears on the TV screen, indicating that the operation is not permitted by the DVD+Hi-Fi VCR or is not available on the disc.

On-Screen Display







General playback status can be displayed on the TV screen. Some menu options can be changed on the menu.

On-screen display operation

- 1** Press DISPLAY during playback.
- 2** Use / to select a menu option. The selected option will be highlighted.

- 3** Use / to change the setting of an option. The number buttons can be also be used for setting numbers (e.g., title number). For some functions, press MEMORY/ENTER to execute the setting.























Temporary Feedback Field Icons

-  Repeat Title
-  Repeat Chapter
-  Repeat A-B
-  Repeat Off
-  Resume play from this point
-  Action prohibited or not available

Notes

- Some discs may not provide all of the features on the on-screen display example shown below.
- If no button is pressed for 10 seconds, the on-screen display disappears.

DVD

Menu Options	Function (Use  /  to select desired option)	Selection Method
Title Number  1 / 3	Shows the current title number and total number of titles, and skips to the desired title number.	 /  , or Numbers, ENTER
Chapter Number  1 / 12	Shows the current chapter number and total number of chapters, and skips to the desired chapter number.	 /  , or Numbers, ENTER
Time search  0:20:09	Shows the elapsed playing time, and searches the point directly from the elapsed time.	Numbers, ENTER
Audio language and Digital Audio Output mode  1 ENG  5.1 CH	Shows the current audio soundtrack language, encoding method, and channel number, and changes the setting.	 /  , or AUDIO
Subtitle language  OFF	Shows the current subtitles language, and changes the setting.	 /  , or SUBTITLE
Angle  1 / 1	Shows the current angle number and total number of angles, and changes the angle number.	 /  , or ANGLE
Sound  BYPASS	Shows the current sound mode, and changes the setting.	 /  , or SOUND MODE

DVD Operation Setup (Continued)

Initial Settings

You can set your own Personal Preferences on the DVD+Hi-Fi VCR.

General Operation

- 1 Press SETUP.**
The Setup menu appears.



- 2 Use ▲/▼ to select the desired option.**
The screen will show the current setting for the selected option, as well as alternate setting(s).
- 3 While the desired option is selected, press ►, then ▲/▼ to select the desired setting.**
- 4 Press ENTER to confirm your selection.**
Some options require additional steps.
- 5 Press SETUP, RETURN, or PLAY to exit the Setup menu.**

Language

Disc Language **DVD**

Select a language for the disc's Menu, Audio, and Subtitle.

Original: The original language set for the disc is selected.
Other: To select another language, use the number keypad to enter the corresponding 4-digit number according to the language code list on page 41. If you enter the wrong language code, press CLEAR.



Menu Language

Select a language for the Setup menu. This is the menu you see when you press SETUP.

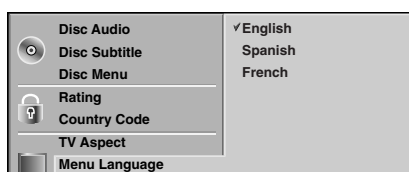

Picture

TV Aspect Ratio **DVD**

4:3 Letterbox: Select when a standard 4:3 TV is connected. Displays theatrical images with masking bars above and below the picture.

4:3 Panscan: Select when a conventional TV set is connected. The video material formatted in the Pan & Scan style is played back in that style (Both sides of the picture are cut off).

16:9 Wide: Select when a 16:9 wide TV is connected.

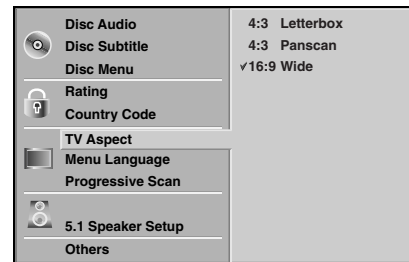

Progressive Scan **DVD**

Progressive Scan Video provides the highest quality pictures with less flickering.
If you are using the COMPONENT VIDEO OUT jacks, but are connecting the DVD Player to a standard (analog) television, set Progressive Scan to Off.
If you are using the Component Video jacks for connection to a TV or monitor that is compatible with a progressive scan signal, set Progressive Scan to On.

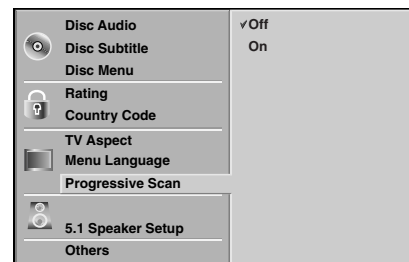

⚠ Caution

Once the setting for progressive scan output is entered, an image will only be visible on a progressive scan compatible TV or monitor. If you set Progressive Scan to On in error, you must reset the unit. Press STOP (■) to stop any disc that is playing. Next, press STOP again and hold it for five seconds before releasing it. The video output will be restored to the standard setting, and a picture will once again be visible on a conventional analog TV or monitor.

DVD Operation Setup (Continued)

5.1 Speaker Setup **DVD**

Select speaker settings, including volume balance and delay time, or test the speaker settings. Speaker settings are only active on the Analog Multi-Channel Output. (See "Speaker Setup", on page 36.)

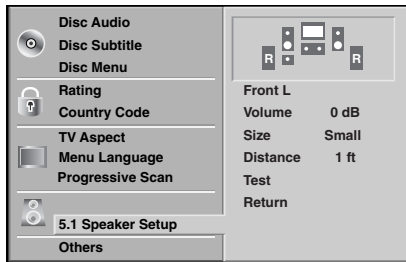

Auto Play **DVD**

You can set up the DVD+Hi-Fi VCR so a DVD disc automatically starts playing whenever the DVD is inserted. If Auto Play mode is set to On, this DVD+Hi-Fi VCR will search a title that playback time is longest and then play back the title automatically.

On: Auto Play function is activated.

Off: Auto Play function is not activated.

Note

The Auto Play function may not work for some DVDs.

Others

The DRC, Vocal, and Auto Play feature settings are adjustable.

- Use ▲/▼ to select the desired option and press MEMORY/ENTER repeatedly. The selected option is toggled On and Off.



Dynamic Range Control (DRC)

With the DVD format, you can hear a program's soundtrack in the most accurate and realistic presentation possible, thanks to digital audio technology. However, you may wish to compress the dynamic range of the audio output (the difference between the loudest sounds and the quietest ones). Then, you may listen to a movie at a lower volume without losing clarity of sound. Set DRC to On for this effect.

Vocal

Set Vocal to On only when a multi-channel karaoke DVD is playing. The karaoke channels on the disc will mix into normal stereo sound.

DVD Operation Setup (Continued)

Parental Control

Rating **DVD**

Movies on DVDs may contain scenes not suitable for children. Therefore, discs may contain Parental Control information that applies to the complete disc or to certain scenes on the disc. These scenes are rated from 1 to 8, and alternatively, more suitable scenes are available for selection on some discs. Ratings are country-dependent. The Parental Control feature allows you to prevent discs from being played by your children or to have certain discs played with alternative scenes.

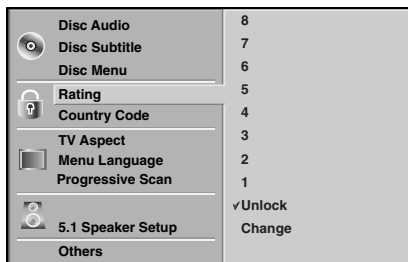

1 Select "Rating" on the Setup menu using the ▲▼ buttons.

2 While "Rating" is selected, press ►.

3 When you have not entered a password.

Enter a 4-digit password using the number buttons to create a personal 4-digit security password. then press MEMORY/ENTER. Enter the 4-digit password again and press MEMORY/ENTER to verify.

When you have already registered a password; Enter a 4-digit password using the numbered buttons to confirm the personal 4-digit security password, then press MEMORY/ENTER.

If you make a mistake before pressing MEMORY/ENTER, press CLEAR and enter 4-digit security password again.

4 Select a rating from 1 to 8 using the ▲▼ buttons. One (1) has the least playback restrictions. Eight (8) has the most playback restrictions.

Unlock: If you select Unlock, Parental Control is not active. The disc will play in full.

Ratings 1 to 8: Some discs contain scenes not suitable for children. If you set a rating for the player, all disc scenes with the same rating or lower will be played. Higher rated scenes will not be played unless an alternative scene is available on the disc. The alternative must have the same rating or a lower one. If no suitable alternative is found, playback will stop. You must enter the 4-digit password or change the rating level in order to play the disc.

5 Press MEMORY/ENTER to confirm your rating selection, then press SETUP to exit the menu.

Note

This function may not work for some DVDs.

Country Code **DVD**

Enter the code of a country/area whose standards were used to rate the DVD video disc, referring to the list (See "Country Code List", page 42.).

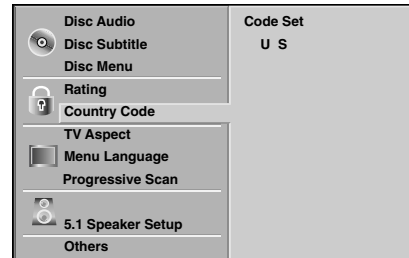

1 Select Country Code using the ▲▼ buttons on the setup menu.

2 While Country Code is selected, press ►.

3 Follow step 3 of "Rating" on left.

4 Select the first character using the ▲▼ buttons.

5 Shift the cursor using ► button and select the second character using ▲▼ buttons.

6 Press MEMORY/ENTER to confirm your country code selection, then press SETUP to exit the menu.

Note

Confirmation of the 4-digit password is necessary when the code is changed (see "Changing the 4-digit code" below.).

Changing the 4-digit code

- 1 Follow Steps 1-2 as shown above to the left (Rating).
- 2 Enter the old code, then press MEMORY/ENTER.
- 3 Select Change using ▲▼ buttons then press MEMORY/ENTER.
- 4 Enter the new 4-digit code, then press MEMORY/ENTER.
- 5 Enter exactly the same code a second time and verify by pressing MEMORY/ENTER.
- 6 Press SETUP to exit the menu.

If you forget your 4-digit code

If you forget your password, to clear the current password, follow the procedure below. (in the NO DISC mode).

- 1 Press SETUP to display the Setup menu.
- 2 Use the Number buttons to enter the 6-digit number "210499".
The 4-digit password is cleared.
- 3 Enter a new code as shown above to the left (Rating).

VCR Operation

Normal Playback

Preparation:

- Turn on the TV.
- Tune the TV to the DVD+Hi-Fi VCR output channel (CH 3 or 4) or set the TV's source selector to VIDEO.
- If a direct VIDEO connection is made between the DVD+Hi-Fi VCR and the TV, set the TV's source selector to VIDEO.
- Set the Output Source to VCR as shown in Setting the Output Source on page 6.

1 Insert a prerecorded video cassette.

The  indicator will light and the DVD+Hi-Fi VCR will power-up automatically.

- Make sure that the  indicator in the display window is not lighted. If it is, press **POWER** once.
- If a tape without a safety tab is inserted, the unit will start playback automatically.

2 Press PLAY (▶) once.

PLAY appears on the TV screen .

- It is not necessary to select the tape speed for playback. It will be automatically selected by the DVD+Hi-Fi VCR.
- In playback, the **TV/VCR** selector switches to VCR mode automatically.

3 Press STOP (■) to stop playback.

STOP appears on the TV screen.

- If the tape reaches the end before STOP (■) is pressed, the DVD+Hi-Fi VCR will automatically stop, rewind and eject the tape, and it will turn itself off.

Tracking Control

Auto Tracking

The automatic tracking function adjusts the picture to remove snow or streaks.

The AUTO TRACKING function works in the following cases:

- A tape is played back for the first time.
- Tape speed (SP, LP, SLP) changes.
- Streaks or snow appear because of scratches on the tape.

Manual Tracking

If noise appears on the screen during playback, press either **CH/TRK ▲/▼** on the remote control until the noise on the screen is reduced.

- If vertical jitter is present, adjust tracking controls very carefully.
- Tracking is automatically reset to normal when the tape is ejected or the power cord is unplugged for more than 3 seconds.

Note

- Only 2-channel stereo (Front Left, Front Right & Subwoofer) is available for VCR mode, thus sound might not be heard from center or rear speakers during VCR playback. (For further details about sound mode, please refer to page 15.)

Special Effect Playbacks

Special effects playback notes

- Horizontal lines (noise bars) will appear on the TV screen. This is normal.
- The audio is automatically muted during special effect modes, so there is no sound during search.
- During high-speed picture search mode, a short period is needed to stabilize tape speed when re-entering the PLAY mode. Slight interference may be observed during this period.

Search

This function lets you quickly and visually search for a desired tape section in either direction: forward or reverse.

- 1 Press **BACKWARD (◀◀)** or **FORWARD (▶▶)** during playback.

The DVD+Hi-Fi VCR will be activated in the SEARCH mode.

- If the DVD+VCR is left in the SEARCH mode for more than 3 minutes, the DVD+Hi-Fi VCR will automatically enter the PLAY mode, to protect the tape and video heads.

- 2 To return to playback, press **PLAY (▶)**.

Still Picture and Frame-by-Frame Playback

- 1 Press **PAUSE/STEP (||)** during playback. Picture movement will stop on one frame.

- If the still picture vibrates vertically, stabilize it using **▲/▼** on the remote control.
- If the DVD+Hi-Fi VCR is left in the STILL mode for more than 5 minutes, the DVD+Hi-Fi VCR will automatically enter the STOP mode to protect the tape and video heads.

- 2 Press **PAUSE/STEP (||)** repeatedly to advance the video one frame at a time while viewing a still picture in Still mode.

- 3 To return to playback, press **PLAY (▶)**.

Slow Motion

- 1 While in Still mode, press **FORWARD (▶▶)**.

The tape will be played back at a speed 1/19 times slower than the normal speed.

- During slow playback, use **▲/▼** on the Remote Control to minimize noise bands.
- If slow motion mode continues for more than 3 minutes, the DVD+Hi-Fi VCR will automatically change to playback mode.

- 2 To return to playback, press **PLAY (▶)**.

CM Skip (Commercial Skip)

This is useful for skipping commercials or short program segments.

- 1 Press **CM SKIP** during playback.

The tape will fast forward picture search through 30 seconds of recording.

- Skipping time can be extended by pressing **CM SKIP** repeatedly.
- Subsequent presses result in advancing the fast forward picture search time by 30-second increments (maximum 3 minutes).

- 2 When the search is complete, the DVD+Hi-Fi VCR will go into playback mode automatically.

VCR Operation (Continued)

Normal Recording

Preparation:

- Turn on the power of both the DVD+Hi-Fi VCR and TV.
- Tune the TV to the DVD+Hi-Fi VCR output channel (CH 3 or 4) or set the TV's source selector to VIDEO.
- If a direct VIDEO/AUDIO connection is made between the DVD+Hi-Fi VCR and the TV, set the TV's source selector to VIDEO.

1 Insert a video cassette with the anti erasure safety tab intact.

2 Select the desired channel with ▲/▼.

- If you are recording from another source via audio/video input jacks (at the Rear or Front panel), select LINE1 or LINE2 with INPUT.

3 Set the desired recording speed (SP or SLP) with SPEED.

- This DVD+Hi-Fi VCR is not designed to record in LP mode.

4 Set the MTS mode as desired (See page 17, 27).

5 Press REC/ITR (●) once.

Recording will start. (The REC indicator will light in the display window.)

- REC indicator appears only when the Output Source is set to VCR.
- If a cassette with no anti erasure safety tab is loaded, the cassette will be ejected automatically.

6 Press STOP (■) twice to stop recording.

If the tape reaches the end before STOP (■) is pressed, the DVD+Hi-Fi VCR will automatically stop, rewind, eject the tape and turn itself off.

Pausing the recording

1 Press PAUSE/STEP (||) to pause the tape during recording.

The REC indicator will flash in the display window.

2 When you want to continue recording, press PAUSE/STEP (||) or REC/ITR (●).

- After 5 minutes in Pause mode, the tape will be stopped automatically to protect the tape and the video heads.

To record one TV program while watching another

- 1 Use TV/VCR to select the TV mode while recording. The TV indicator appears.
- 2 Using the TV, select the channel to be viewed.

Tips

Always use PAUSE/STEP (||) for best results when making changes while recording. For example: To change channels while recording, first press PAUSE/STEP (||) to put the unit in pause mode. Select the desired channel on the DVD+Hi-Fi VCR, then press PAUSE/STEP (||) again to resume recording.

Timer Recording

This DVD+Hi-Fi VCR can be programmed to record up to 8 programs within a period of 1 year. For unattended recording, the timer needs to know the channels to be recorded and the starting and ending times.

Things to know before starting

- If you try to set the program timer before setting the clock, PLEASE SET THE CLOCK appears for a moment and then CLOCK menu appears on the TV screen. Set the time and date before proceeding.
- Make sure a tape is in the DVD+Hi-Fi VCR and the anti erasure safety tab is in place or the tape will be automatically ejected.

Preparation:

- Turn on the power of both the DVD+Hi-Fi VCR and the TV.
- Be sure the TV is set to the DVD+Hi-Fi VCR output channel (3 or 4).
- Make sure the TUNING BAND in the TUNING menu is set appropriately (TV or CATV).

1 Press MENU and the MAIN menu will appear.

2 Use ▲/▼ to choose the PROGRAM menu.

3 Press MEMORY/ENTER to go to the PROGRAM menu.

The PROGRAM menu will appear.

- If all 8 programs have been entered, FULLY PROGRAMMED message will appear for a moment and then PROGRAM 1 will appear on the TV screen.

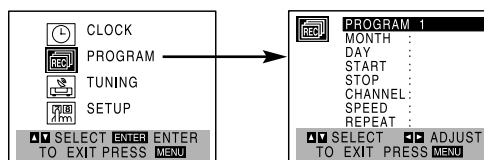

4 Use ◀/▶ to choose the PROGRAM No. (1-8).

5 Use ▼ to choose the MONTH option.

Use ◀/▶ to choose the desired month.

6 Use ▼ to choose the DAY option.

Use ◀/▶ to choose the desired day.

7 Use ▼ to choose the START option.

Use ◀/▶ to choose the desired start time.

8 Use ▼ to choose the STOP option.

Use ◀/▶ to choose the desired stop time.

9 Use ▼ to choose the CHANNEL option.

Use ◀/▶ to choose the desired channel (Channel, LINE1 or LINE2).

Cable Users: If you have CABLE TV and used Cable Box in Connecting Antenna/Cable TV to DVD+Hi-Fi VCR (page 11), using a cable box converter, you must set the channel in this step to match the cable box output channel (usually CH 3 or 4). Change channels on the cable box instead of with the DVD+Hi-Fi VCR.

VCR Operation (Continued)

10 Use **▼** to choose the **SPEED** option.
Use **◀▶** to choose the desired recording speed (**AUTO**, **SP** or **SLP**).

- **AUTO** mode determines how much tape is left and switches speed from **SP** to **SLP**, if necessary, to complete recording the program. There will be some picture and sound distortion at the point of the speed change.

11 Use **▼** to choose the **REPEAT** option.
Use **◀▶** to choose the desired repeat (**ONCE**, **WEEKLY** or **DAILY**).

- **ONCE event**....for recording up to 8 programs on a single day or over the days within a period of 1 year.
- **WEEKLY event**....for recording up to 8 programs on a certain day of every week.
- **DAILY event**....for recording up to 8 programs at the same time(s) Monday through Friday.

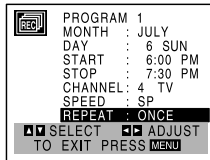

Tip

If the input data is wrong, use **▲** to select the data and correct it using **◀▶**.

12 Press **MENU**, the program will be memorized by the DVD+Hi-Fi VCR.

- **⌚** indicator lights in the display window.
- If the program preset time has past, the **PAST TIME PROGRAMMED** message will appear on the TV screen. Return to the incorrect program and program it with the correct time.
- If you had entered a past date, timer recording will be performed on that date of the next year.
- Additional programs may be entered by repeating steps 1-12.

Cable Users: If your cable hookup is via a TV converter box, you can program multiple recordings only on the converter box output channel. This is because the converter determines what channel you view through your DVD+Hi-Fi VCR.

Tip

If you are finished programming and you want to set the DVD+Hi-Fi VCR to record the programs you have entered, **MAKE SURE YOU HAVE INSERTED A TAPE INTO THE DVD+VCR**. The DVD+Hi-Fi VCR is now set to record the pre-set programs.

After setting up a timer recording, recording will start if no other timer recordings overlap the start time, see next column.

Notes

- If the power fails or the DVD+Hi-Fi VCR is unplugged from the AC outlet, the correct clock time and timer settings are kept in memory for approximately 3 seconds. After 3 seconds, the clock and program timer must be reset when power is restored. Reset the clock according to instructions.
- After timer recording is completed, the DVD+Hi-Fi VCR will turn off automatically.
- To watch a TV program while timer recording is in progress, select Tuner mode by pressing **TV/VCR** repeatedly.
- If you wish to stop timer recording which has already started, press **STOP** or **POWER** twice.

Checking (Erasing) Timer Record Programming

Programming can be checked whenever the DVD+Hi-Fi VCR is turned on.

- 1 Press **MENU** and the **MAIN** menu will appear.
- 2 Use **▲/▼** to choose the **PROGRAM** menu.
Press **MEMORY/ENTER** and the **PROGRAM** menu will appear.

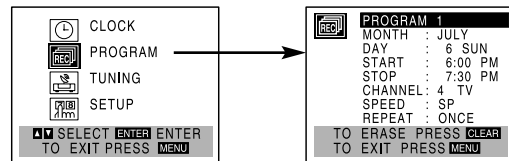

- 3 Use **◀▶** to select a program you want to check or erase. If you want to erase the program, press **CLEAR**.
- 4 Press **MENU** to return to the TV screen.

Program Priority

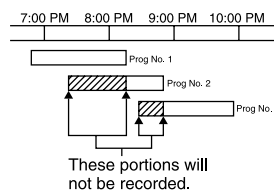

number 1 is finished.

The first part of program number 2 will not be recorded. The same thing will happen to program number 3.

If the recording start and end times of preset programs overlap on the same day (see the example and diagram left), program number 2 will not be recorded until program

VCR Operation (Continued)

Instant Timer Recording

Instant Timer Recording allows you to make a recording easily of a preset length without using the programmable timer.

Preparation:

- Turn on the power of both the DVD+Hi-Fi VCR and the TV.
- Be sure the TV is tuned to the DVD+Hi-Fi VCR output channel (3 or 4).
- If a direct VIDEO/AUDIO connection is made between the DVD+Hi-Fi VCR and the TV, set the TV's source selector to VIDEO.

1 Insert a video cassette with the anti erasure safety tab intact.

2 Select the desired channel with ▲/▼ or number (0-9).

The channel number appears on the TV screen.

- If you are recording from another source via audio/video input jacks (at the Rear or Front panel), select LINE1 or LINE2. with INPUT.

3 Select the desired recording speed (SP or SLP) with SPEED.

The tape speed will appear on the TV screen.

4 Press REC/ITR (●) twice.

The menu as illustrated, will appear on the TV screen.

- Recording will start. (The ☺ indicator will light)

5 Press REC/ITR (●) repeatedly to select the recording time length.

At the end of the recording, the DVD+Hi-Fi VCR will stop recording and shut off.

- While Instant Timer Recording is active, changing the channel on the DVD+Hi-Fi VCR will not be possible.
- To stop the recording, press STOP or POWER twice.

INSTANT TIMER RECORD MENU

INSTANT TIMER RECORD	
CHANNEL	2
SPEED	SP
START LENGTH	NOW 0H30M

0H30M 9H00M → 0H00M
↑
Length Display
(each additional press of
REC/ITR (●) increases recording
time 30 minutes)

Checking the Recording Time

Press REC/ITR (●) once to check the recording time. The recalled setting will automatically return to the TV screen after 6 seconds.

To extend the Recording Time

The recording time can be extended anytime by pressing REC/ITR (●).

Subsequent presses result in advancing the recording time by 30-minute increments.

Notes

- If you press PAUSE/STEP (||) while in instant timer recording mode, the DVD+Hi-Fi VCR will enter the recording pause mode. Instant timer recording is cancelled.
- If the DVD+Hi-Fi VCR is set to "0H00M", the DVD+Hi-Fi VCR goes to normal recording mode.

Dubbing and Editing

If you wish to edit or dub your camcorder (or another VCR) recordings to this DVD+Hi-Fi VCR, the rear (or Front) panel mounted Audio and Video (A/V) input jacks make the connections quick and easy. These direct A/V jacks will also provide better picture results than using the RF jack on the rear panel.

1 Connect the camcorder's (or another VCR's) A/V outputs to your DVD+Hi-Fi VCR as illustrated on page 13.

2 Set the input channel "LINE2". (Use INPUT to select LINE2.)

- If you have connected your DVD+Hi-Fi VCR to the A/V input jacks on the rear of DVD+Hi-Fi VCR, you should select the input channel LINE1 by pressing INPUT twice.

3 Play the tape in the camcorder (or another VCR). If you have a TV attached to your DVD+Hi-Fi VCR, you can see the video playing.

4 When you desire the recording to begin, press DVD+Hi-Fi VCR's REC/ITR (●) once to start.

Notes

- Before recording, please confirm the recording start position.
- To stop the editing, press STOP (■) twice.

Copying from DVD to VCR

This unit is capable of copying the contents of a DVD to a VHS tape.

Notes

If the DVD you are attempting to copy is copy protected, you will not be able to copy the disc. It is not permitted to copy Macrovision encoded DVDs. "LOCK" is displayed in the display window.

1 Insert Disc

Insert the disc you wish to copy in the DVD deck and close the disc tray.

2 Insert VHS Tape

Insert a blank VHS video tape into the VCR deck.

3 Press PLAY (▶) on the DVD deck.

The DVD will go into play mode

- If the DVD disc menu appears, you may need to press PLAY (▶) manually to begin copying.

4 Press REC/ITR (●) on the front panel or remote control.

- The DVD+Hi-Fi VCR will go into Record mode.
- "COPY" indicator will light.

5 Stop the Copy Process

When the DVD is finished playing, press STOP (■) or POWER twice to end copying.

You must stop the Copy process manually when the DVD movie ends, or the unit may replay and record over and over again.

Notes

When you stop the DVD playback during copying, VCR recording mode also stops automatically.

VCR Operation (Continued)

VHS Hi-Fi Stereo System/ MTS Broadcast

This DVD+Hi-Fi VCR is equipped with the VHS Hi-Fi audio sound system for recording and playback. The information below gives a brief description of Hi-Fi audio and how to record and play a tape in the Hi-Fi audio mode.

- 1 Set the **AUDIO MODE** option to **Hi-Fi** on the **SETUP** menu .

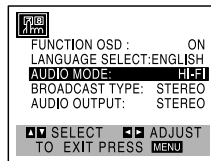

- 2 Set the **AUDIO OUTPUT** option to **STEREO** position.

(STEREO) POSITION: The left channel sound (L) is heard from the left speaker and the right channel sound (R) is heard from the right speaker.

(LEFT) POSITION: The left channel sound (L) is heard from both speakers.

(RIGHT) POSITION: The right channel sound (R) is heard from both speakers.

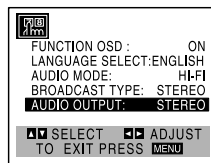

- 3 Press **MENU**.

- 4 Insert a cassette and press **PLAY (▶)**.
Adjust volume at your stereo system.

MTS (Multi-Channel TV Sound)

This DVD+Hi-Fi VCR will decode MTS stereo and bilingual (SAP) off-the-air broadcast sound signals. It also decodes stereo TV sound from local cable companies, as long as they operate on assigned cable frequencies and use the EIA-recommended MTS stereo/bilingual TV sound system.

Multichannel TV Sound Indicator (MTS)

Shows onscreen as illustrated below when **MEMORY/ENTER** is pressed.

- One or both of the indicators will light, depending on the MTS broadcast.

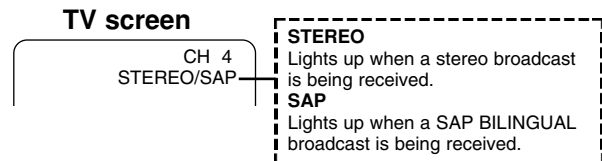

If only **STEREO** appears on the TV screen.

The DVD+Hi-Fi VCR can record in stereo onto the VHS Hi-Fi audio tracks when the **BROADCAST TYPE** option is in the **STEREO** position. The DVD+Hi-Fi VCR will also record mono audio onto the mono audio track.

If only **SAP** appears on the TV screen.

Set the **BROADCAST TYPE** option to **SAP**.

If **STEREO/SAP** appears on the TV screen

Use the **BROADCAST TYPE** option to select the desired recording mode (**STEREO** or **SAP**).

SAP (Second Audio Program) Recording

Some stations transmit a Second Audio Program, which is used for a second language or additional information. When the station broadcasts a Second Audio Program, follow the procedure below to record the SAP.

- 1 Insert a video cassette with the anti erasure safety tab intact.

- 2 Set the **BROADCAST TYPE** option to **SAP** (**SETUP** menu).

Do this if only the **SAP** appears on the TV screen or you know the program will use the **SAP**.

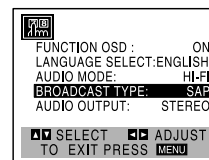

- 3 Press **MENU**.

- 4 Select the desired recording speed (**SP** or **SLP**) with **SPEED**.

- 5 Select the desired channel. **SAP** should appear on the TV screen.

- 6 Press **REC/ITR (●)** once

You are now recording the program you see and hear on the TV.

- 7 Press **STOP (■)** twice to stop recording.

VCR Operation (Continued)

Tape Counter Memory Feature

Real-Time Counter

Shows length of tape run in hours, minutes, and seconds. Press **CLK/CNT** to select the real-time counter display.

Every press of **CLK/CNT** changes the TV screen display as illustrated below.

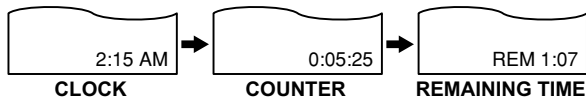

- Counter changes to "0:00:00" when the cassette is ejected.
- The real-time counter does not operate if nothing is recorded on the tape.
- The real-time counter will not work unless a tape is inserted.

Counter Memory Feature

This is useful if there is a section of tape you want to view immediately after recording or if you want to return to the same point several times.

- 1** Begin recording or playing a tape.
- 2** Press **CLK/CNT** repeatedly to display the real-time counter on the TV screen.
- 3** At the point that you want to locate later, reset the real-time counter to "0:00:00" by pressing **CLEAR**.
- 4** Continue to play or record.
- 5** Press **STOP** (■) once or twice when recording or playback finishes.
- 6** Press **BACKWARD** (◀◀).
The tape automatically stops when the tape counter returns to about "0:00:00".

Tape Remaining

This function shows the remaining time on the tape during recording or playback.

Press **CLK/CNT** repeatedly until the REM indicator appears on the TV screen during recording or playback.

Note

The remaining tape length indicator may not be displayed correctly depending on the condition of the tape and the kind of the tape (T-140, T-160, or T-210 etc.)

Additional Information

- In manual recording, Timer recording, Instant Timer Recording, playback, or fast forward modes, the DVD+Hi-Fi VCR automatically starts rewinding the tape at the end of the tape. The cassette will stop at the beginning of the tape and be ejected, and the DVD+Hi-Fi VCR will turn itself off.
- After you have finished using the DVD+Hi-Fi VCR, rewind, eject, and remove the cassette. Place the cassette in its protective sleeve to protect it from dust. It is not necessary to rewind the cassette before removing it, but if you do, it will be ready to play or record the next time you use it.
- Be sure the DVD+Hi-Fi VCR Channel Selector is on the correct channel you wish to record. The channel that is being recorded can always be checked by tuning the television to the DVD+Hi-Fi VCR channel (3 or 4) and using the **TV/VCR** selector to turn the DVD+Hi-Fi VCR's TV indicator off.
- Do not attempt to hook up more than one television set to the DVD+Hi-Fi VCR for either recording or playback.

Auto Play System

This DVD+Hi-Fi VCR features automatic playback. Load a cassette (with the safety tab removed).

- The Output Source is changed to VCR mode automatically.
- The power turns on automatically and playback begins.
- At the end of the tape, the DVD+Hi-Fi VCR stops and rewinds the tape.
- The cassette is ejected after rewinding and the VCR turns itself off automatically.

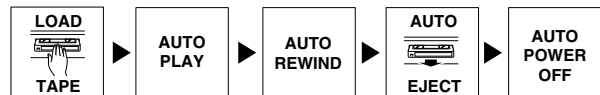

Note

Auto power off does not function during regular DVD play mode. (DVD+Hi-Fi VCR power stays on.)

DVD Operation

Playing a DVD



Playback Setup **DVD**

- Turn on the TV and select the video input source connected to the DVD+Hi-Fi VCR.

1 Press OPEN/CLOSE () to open the disc tray.

2 Load your chosen disc in the tray, with the label facing up.





When a double-sided DVD is inserted, make sure the side you want to play is facing down.

3 Press OPEN/CLOSE () to close the tray. "READING" appears in the display window, and playback starts automatically. If playback does not start, press PLAY ().
In some cases, the disc menu might appear instead.

If a menu screen is displayed

The menu screen may be displayed first after loading a DVD or Video CD which offers a menu.

DVD

Use , , ,  buttons to select the title/chapter you want to view, then press MEMORY/ENTER to start playback.

Press TITLE or DISC MENU to return to the menu screen.

Notes

- If Parental Control is set and the disc is not within the Rating settings (not authorized), the 4-digit password must be entered and/or the disc must be authorized (see Parental Control, on page 22).
- DVDs may have a Regional Code.
- Your DVD+Hi-Fi VCR will not play discs that have a Regional Code different from your DVD+Hi-Fi VCR. The Regional Code for this DVD+Hi-Fi VCR is 1 (one).
- Do not keep a fixed image displayed on the screen for a long time.



General Features

Note

Unless stated otherwise, all operations described use the remote control. Some features may also be available on the Setup menu.

Changing TITLES **DVD** 1/3







When a disc has more than one title, you can select another title as follows:

- Press DISPLAY, then use the appropriate number button (0-9) to select a title number.
- Use   to select a title, then press MEMORY/ENTER.















Changing Chapters

DVD 1/12 1/3

When a title on a disc has more than one chapter or a disc has more than one track, you can move to another chapter as follows:

- Press BACKWARD () or FORWARD () briefly during playback to return to the beginning of the current chapter/track or to select the next chapter/track.
- Press BACKWARD () twice briefly to step back to the previous chapter/track.
- To go directly to any chapter during DVD playback, press DISPLAY. Then, use ,  to select the chapter/track icon. Then, enter the chapter/track number using the numbered buttons (0-9) or use   to select the chapter/track, then press MEMORY/ENTER.

Slow Motion **DVD**

- 1 Press PAUSE/STEP () while in Playback mode. The DVD+Hi-Fi VCR will now go into Pause mode.
- 2 Press BACKWARD () or FORWARD () while in Playback mode. The DVD+Hi-Fi VCR will enter SLOW mode.
- 3 Use BACKWARD () or FORWARD () to select the required speed:  1/16,  1/8,  1/4,  1/2 (backward), or  1/16,  1/8,  1/4,  1/2 (forward).
- 4 To return to playback, press PLAY ().

DVD Operation (Continued)

General Features (Continued)

Still Picture and Frame-by-Frame Playback

DVD

- 1 Press PAUSE/STEP (II) while in playback mode. The DVD+Hi-Fi VCR will go into PAUSE mode.
- 2 With a DVD, you can advance the picture frame by frame by pressing PAUSE/STEP (II) repeatedly on the remote control.
- 3 To return to playback, press PLAY (▶).

Search DVD

- 1 Press and hold BACKWARD (◀◀) or FORWARD (▶▶) for about two seconds while in playback mode. The DVD+Hi-Fi VCR will now go into SEARCH mode.
- 2 Press and hold BACKWARD (◀◀) or FORWARD (▶▶) repeatedly to select the required speed: ◀◀X2, ◀◀X4, ◀◀X16, ◀◀X100 (backward) or ▶▶X2, ▶▶X4, ▶▶X16, ▶▶X100 (forward).
- 3 To return to playback, press PLAY (▶).

Repeat DVD



DVD Video Discs - Repeat Chapter/Title/Off

- 1 To repeat the currently playing chapter, press REPEAT. The Repeat Chapter icon appears on the TV screen.
- 2 To repeat the title currently playing, press REPEAT a second time. The Repeat Title icon appears on the TV screen.
- 3 To exit Repeat mode, press REPEAT a third time. The Repeat Off icon appears on the TV screen.

Repeat A-B DVD

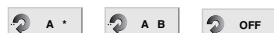

To repeat a sequence in a title:

- 1 Press REPEAT A-B at your chosen start point. A* appears briefly on the TV screen.
- 2 Press REPEAT A-B again at your chosen end point. A B appears briefly on the TV screen, and the repeat sequence begins.
- 3 To cancel the sequence, press REPEAT A-B.

Time Search DVD



The Time Search function allows you to start playing at any chosen time on the disc.

- 1 Press DISPLAY during playback. The on-screen display appears on the screen. The Time Search box shows the elapsed playing time of the current disc.
- 2 Within 10 seconds, use ▲/▼ to select the Time Search icon in the on-screen display. The “-:--:--” display appears in the Time Search box.
- 3 Within 10 seconds, use the numbered buttons to enter the required start time. Enter hours, minutes and seconds from left to right in the box. If you enter the wrong numbers, press CLEAR to remove the numbers you entered. Then enter the correct numbers.
- 4 Within 10 seconds, press MEMORY/ENTER. Playback starts from the selected time on the disc. If you enter an invalid time, playback will continue from the current point.

3D Surround DVD



This unit can produce a 3D Surround effect, which simulates multi-channel audio playback from two conventional stereo speakers, instead of the five or more speakers normally required to listen to multi-channel audio from a home theater system.

- 1 Press DISPLAY during playback.
- 2 Use ▲/▼ to select the sound icon. The sound option will be highlighted.
- 3 Use ◀/▶ to select “3D SUR”. To turn off the 3D Surround effect, select “BYPASS”.

Zoom DVD

The Zoom function allows you to enlarge the video image and to move through the enlarged image.

- 1 Press ZOOM during playback or still playback to activate the Zoom function. If you press ZOOM repeatedly, the magnification level increases up to six steps.
- 2 Use ◀/▶/▲/▼ buttons to move through the zoomed picture.
- 3 Press CLEAR to resume normal playback or return to the paused image.

Notes

- The Zoom function may not work for some DVDs.
- The Zoom function may not work on multi-angle scenes.

DVD Operation (Continued)

General Features (Continued)

Marker Search



You can start playback from a memorized marker. Up to nine markers can be memorized.

To enter a mark, follow these steps.

- 1 From Playback mode, press **MARKER** when playback reaches the spot that you want to memorize. The Marker icon will appear on the TV screen briefly.
- 2 Repeat step 1 to enter up to nine Marker points on a disc.

To Recall a Marked Scene

- 1 From Playback mode, press **SEARCH**. The Marker Search menu will appear on the screen.
- 2 Within 10 seconds, use **◀▶** or number button to select a Marker number that you want to recall.
- 3 Press **MEMORY/ENTER**. Playback will start from the Marked scene.
- 4 To remove the **MARKER SEARCH** menu, press **SEARCH**.

To Clear a Marked Scene

- 1 From Playback mode, press **SEARCH**. The Marker Search menu will appear on the screen.
 - 2 Within 10 seconds, use **◀▶** or number button to select a Marker number that you want to erase.
 - 3 Press **CLEAR**. The Marker number will be erased from the list.
 - 4 Repeat steps 2 and 3 to erase additional Marker numbers.
 - 5 To remove the **MARKER SEARCH** menu, press **SEARCH**.
- All markers are erased when the disc is ejected.

Special DVD Features

Checking the contents of DVD Video discs: Menus

DVDs may contain menus that allow you to access special features. To use the disc menu, press **DISC MENU**. Then, press the appropriate number button to select an option. Or, use **◀/▶/▲/▼** buttons to highlight your selection, then press **MEMORY/ENTER**.

Title Menu

- 1 Press **TITLE**. If the current title has a menu, the menu will appear on the screen. Otherwise, the disc menu may appear.
- 2 The menu can list camera angles, spoken language and subtitle options, and chapters for the title.
- 3 To remove the title menu, press **TITLE** again.

Disc Menu

- 1 Press **DISC MENU**. The disc menu is displayed.
- 2 To remove the disc menu, press **DISC MENU** again.

Camera Angle

If the disc contains sequences recorded from different camera angles, the angle icon blinks on the TV screen. You can then change the camera angle if you wish.

- Press **ANGLE** repeatedly during playback to select a desired angle. The number of the current angle appears on the display.

Changing the Audio Language



Press **AUDIO** repeatedly during playback to hear a different audio language or audio track.

Subtitles

Press **SUBTITLE** repeatedly during playback to see the different subtitle languages.

Note

If  appears, the feature is not available on the disc.

Audio CD or MP3/WMA Disc Operation

Playing an Audio CD or MP3/WMA Disc

CD **MP3** **WMA**

The DVD/CD receiver can play MP3/WMA formatted recordings on CD-ROM, CD-R or CD-RW discs. Before playing MP3/WMA recordings, read the notes on MP3/WMA Recordings on right.

1 Insert a disc and close the tray.

Audio CD; Audio CD menu appears on the TV screen go to step 4.

MP3/WMA disc; The MP3/WMA-JPEG choice menu appears on the TV screen. Go to step 2



2 Use ▲/▼ to select the MP3/WMA then press ENTER.

The MP3/WMA menu appears on the TV screen. Press RETURN to move to the MP3/WMA-JPEG choice menu.

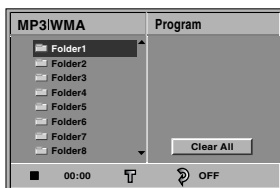

3 Use ▲/▼ to select a folder, and ENTER.

A list of files in the folder appears.

4 Use ▲/▼ to select a track then press PLAY or ENTER.

Playback starts.

During playback, the current track's elapsed playing time will appear on the display window and menu.

Playback will stop at the end of the disc.

Press TITLE to move to the next page.

Press MENU to move to the previous page.

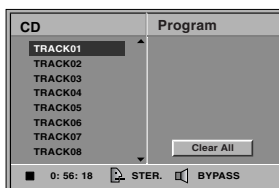

Audio CD Menu

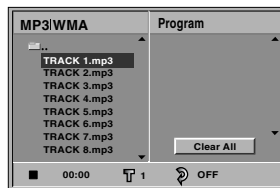

MP3/WMA Menu



If you are in a file list and want to return to the Folder list, use the ▲/▼ to highlight  and press ENTER to return to the previous menu screen.

5 To stop playback at any other time, press STOP.

Notes on MP3/WMA Recordings

About MP3

- An MP3 file is audio data compressed by using the MPEG1 audio layer-3 file-coding scheme. We call files that have the ".mp3" file extension "MP3 files".
- The player can not read an MP3 file that has a file extension other than ".mp3".

About WMA (Window Media Audio)

- A WMA file is Microsoft audio compression technology.
- WMA(Windows Media Audio) offers double the audio compression of the MP3 format.

MP3/WMA Disc compatibility with this DVD/CD receiver is limited as follows:

1. Sampling Frequency / only at 44.1kHz (MP3), 32 - 44.1kHz (WMA)
2. Bit rate / within 32 - 320kbps (MP3), 32 - 128kbps (WMA)
3. CD-R physical format should be "ISO 9660"
4. If you record MP3/WMA files using the software which cannot create a FILE SYSTEM, for example "Direct-CD" etc., it is impossible to playback MP3/WMA files. We recommend that you use "Easy-CD Creator", which creates an ISO9660 file system.
5. A single session disc requires MP3/WMA files in the first track. If there is no MP3/WMA file in the 1st track, it cannot playback MP3/WMA files. If you wish to playback MP3/WMA files, format all the data in the disc or use a new one.
6. File names should be named using 8 letters or less and must incorporate ".mp3" or ".wma" extension e.g. "*****.MP3" or "*****.WMA".
7. Do not use special letters such as "/ : * ? < >" etc.
8. Total number of files on the disc should be less than 650.

This DVD/CD receiver requires discs/recordings to meet certain technical standards in order to achieve optimal playback quality. Pre-recorded DVDs are automatically set to these standards. There are many different types of recordable disc formats (including CD-R containing MP3 or WMA files). That require certain pre-existing conditions (see above) to insure compatible playback.

Customers should also note that permission is required in order to download MP3/WMA files and music from the Internet. Our company has no right to grant such permission. Permission should always be sought from the copyright owner.

Audio CD or MP3/WMA Disc Operation (Continued)

Pause **CD** **MP3** **WMA**

- 1 From Playback mode, press PAUSE/STEP (II) during playback.
- 2 To return to playback, press PLAY, PAUSE/STEP (II) or MEMORY/ENTER again.

Moving to another Track **CD** **MP3** **WMA**

- From Playback mode, press BACKWARD (I◀◀) or press FORWARD (▶▶I) briefly to return to the beginning of the current track or to go to the next track.
- Press BACKWARD (I◀◀) or FORWARD (▶▶I) twice briefly to step back to the previous track.
- From Playback mode for audio CDs, to go directly to any track, enter the track number using the numbered buttons (0-9) during playback.

Repeat Track/All/Off **CD** **MP3** **WMA**

- 1 To repeat the track currently playing, press REPEAT. The Repeat icon and "TRACK" appears on the menu screen.
- 2 To repeat all tracks on a disc, press REPEAT a second time. The Repeat icon and "ALL" appear on the menu screen.
- 3 To cancel Repeat mode, press REPEAT a third time. The Repeat icon and "OFF" appear on the menu screen.

Search **CD** **MP3** **WMA**

- 1 From Playback mode, press and hold BACKWARD (I◀◀) or FORWARD (▶▶I) for about two seconds during playback. The DVD+Hi-Fi VCR will now go into SEARCH mode.
- 2 Press and hold BACKWARD (I◀◀) or FORWARD (▶▶I) repeatedly to select the required speed: ◀◀X2, ◀◀X4, ◀◀X8 (backward) or ▶▶X2, ▶▶X4, ▶▶X8 (forward). Search speed and direction are indicated on the menu screen.
- 3 To return to playback, press PLAY.

Repeat A-B **CD**

To repeat a sequence.

- 1 From Playback mode, press REPEAT A-B at your chosen starting point. The Repeat icon and "A *" appear on the menu screen.
- 2 Press REPEAT A-B again at your chosen end point. The Repeat icon and "A B" appear on the menu screen, and the sequence begins to play repeatedly.
- 3 To exit the sequence and return to normal play, press REPEAT A-B again. The Repeat icon and "OFF" appear on the menu screen.

3D Surround **CD**

This unit can produce a 3D Surround effect, which simulates multi-channel audio playback from two conventional stereo speakers, instead of the five or more speakers normally required to listen to multi-channel audio from a home theater system.

- 1 Press SOUND MODE to select "3D SUR" during playback.
- 2 To turn off the 3D Surround effect, press SOUND MODE again to select "BYPASS".

Changing the Audio Channel **CD**

From Playback mode, press AUDIO repeatedly to hear a different audio channel (STER., LEFT, or RIGHT).

JPEG Disc Operation

Viewing JPEG files **JPEG**

This DVD+Hi-Fi VCR can play discs with JPEG files and Kodak picture CDs. Before playing JPEG files, read the notes on JPEG Files on right.

- 1 Insert a disc and close the tray.**
The MP3/WMA-JPEG choice menu appears on the TV screen.



- 2 Use ▲/▼ to select the JPEG option then press MEMORY/ENTER.**

The JPEG menu appears on the TV screen.



- 3 Use ▲/▼ to select a folder, and press MEMORY/ENTER or PLAY.**

A list of files in the folder appears.
Press RETURN to move to the MP/WMA-JPEG choice menu.

Tip

If you are in a file list and want to return to the Folder list, use the ▲/▼ buttons on the remote to highlight “...” and press ENTER to return to the previous menu screen.

- 4 If you want to view a particular file, use ▲/▼ to highlight a file and press MEMORY/ENTER or PLAY.**

Viewing the file proceeding starts.
During viewing a file function, press RETURN to move to the previous menu (JPEG menu).
Press TITLE to move to the next page.
Press MENU to move to the previous page.

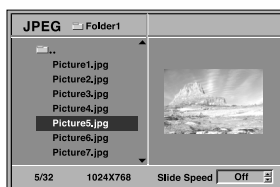

Tip

There are three Slide Speed viewing options: Fast, Normal, Slow, and Off. Use ◀▶ to highlight the Slide Speed option then use ▲/▼ to select the speed you want to view the slides at, and press MEMORY/ENTER.

- 5 To stop viewing at any other time, press STOP.**
The JPEG menu appears.

Selecting Files

Press SKIP/SCAN ◀◀ or ▶▶ once while viewing a picture to advance to the next file or to the previous file.

Still Picture

- 1 Press PAUSE/STEP (||) during slide show.
The DVD+Hi-Fi VCR will now go into PAUSE mode.
- 2 To return to the slide show, press PLAY or press PAUSE/STEP (||) again.

Flipping the picture

Press ▲/▼ while showing a picture to flip the picture horizontally or vertically.

To rotate picture

Press ◀▶ during showing a picture to rotate the picture clockwise or counterclockwise.

Notes on JPEG Files

- Depending upon the size and number of the JPEG files, it could take a long time for the DVD+Hi-Fi VCR to read the disc's contents. If you don't see an on-screen display after several minutes, some of the files are too big — reduce the resolution of the JPEG files to less than 2 mega pixels and burn another disc.
- Total number of files and folders on the disc should be less than 650.
- Some disc may be incompatible due to different recording format or condition of disc.
- When you are using software such as “Easy CD Creator” to burn the jpeg files into the CD-R, ensure that all the selected files have the “.jpg” extensions when copying into the CD layout.
- If the files have “.jpe” or “.jpeg” extensions, please rename them as “.jpg” files.
- File names without “.jpg” extension will not be able to be read by this DVD+Hi-Fi VCR. Even though the files are shown as JPEG image files in windows explorer.

Programmed Playback **CD** **MP3** **WMA**

Programmed Playback with Audio CDs and MP3/WMA Discs

The Program function enables you to store your favorite tracks from any disc in the player memory.

Program can contain 30 tracks.

1 From Playback or in the Stop mode, press PROGRAM to enter the Program Edit mode.

The [E] mark will appear to the right of the word Program on the right side of the menu display.

Note

Press PROGRAM to exit the Program Edit mode; the [E] mark will disappear.

2 Select a track, then press ENTER to place the selected track on the Program list.

3 Repeat step 2 to place additional tracks on the Program list.

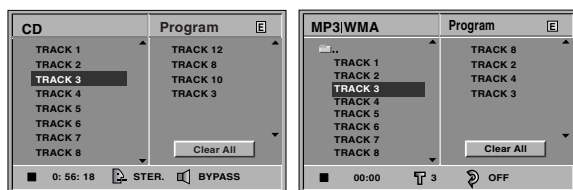

Audio CD Menu

MP3/WMA Menu

4 Press ►.

The programmed track you selected last is highlighted on the program list.

5 Use ▲/▼ to select the track you want to start playing.

Press TITLE to move to the next page.

Press MENU to move to the previous page.

6 Press PLAY to start.

Playback begins in the order in which you programmed the tracks and "PROG." appears on the menu display. Playback stops after all of the tracks on the Program list have played once.

7 To resume normal playback from programmed playback, select a track from the CD (or MP3/WMA) list and then press ENTER.

"PROG." indicator disappears from the menu display.

Repeat Programmed Tracks

- To repeat the track currently playing, press REPEAT. The Repeat icon and "TRACK" appear on the menu screen.
- To repeat all tracks on the program list, press REPEAT a second time. The Repeat icon and "ALL" appear on the menu screen.
- To cancel Repeat mode, press REPEAT a third time. The Repeat icon and "OFF" appear on the menu screen.

Erasing a Track from Program List

1 From Playback or in the Stop mode, (Audio CD or MP3/WMA disc only) press PROGRAM to enter the Program Edit mode.

The [E] mark will appear.

2 Press ► to move to the Program list.

3 Use ▲/▼ to select the track that you wish to erase from the Program list.

4 Press CLEAR.

The track will be erased from the Program list.

Erasing the Complete Program List

1 Follow steps 1-2 of "Erasing a Track from Program List" as above.

2 Use ▲/▼ to select "Clear All", then press ENTER.

The complete Program for the disc will be erased.

The programs are also cleared when the disc is removed.

Speaker Setup

Adjust the Speaker Setup menu option settings for the built-in 5.1 channel surround decoder. (Also refer to page 14, Speaker Positioning.)

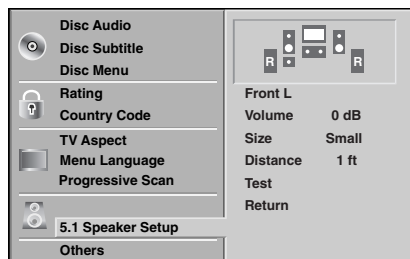

- 1** Select “5.1 Speaker Setup” on the Setup menu using the ▲/▼ buttons.
- 2** While “5.1 Speaker Setup” is selected, press ► button.
- 3** Use ► button to select the desired speaker.
- 4** Adjust options by using ▲▼◀▶ buttons.

Speaker Selection

Select a speaker that you want to set up. ((Front speakers (Left), Front speakers (Right), Center Speaker, Rear speakers (Left), Rear speakers (Right), Subwoofer))

Note

Certain speaker settings are prohibited by the Dolby Digital licensing agreement.

Volume

Use ◀/▶ to adjust the output level of the selected speaker. (-6dB ~ +6dB)

Size

Speaker size settings are fixed, you cannot change the settings.

Distance

If you connected speakers to your DVD+Hi-Fi VCR, specify the Distance from each speaker to the listener, you want to make the sound from each speaker reach the listener at the same time. (1 ft = 30.48 cm)

Note

You can not set the distance of subwoofer speaker.

Test

Press MEMORY/ENTER to test the signals of each speaker. Adjust the volume to match the volume of test signals memorized in the system.

- Front Left (L) → Front Right (R) → Center → Rear Left (L) → Rear Right (R) → Subwoofer

Return

Press MEMORY/ENTER to return to the previous menu.

Radio Operation

Presetting Radio Stations

You can preset 30 stations for FM and AM. Before tuning, make sure that you have turned down the sound level.

- 1 Press **FM/AM** on the remote control or on the front panel until the frequency band appears on the display and TV screen.

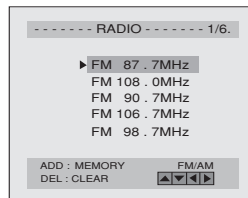

- 2 Use **▲/▼** on the remote control to find your desired station.

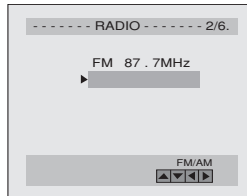

- 3 Use **FM/AM** on the remote control or on the front panel to select the desired band.

- 4 Hold down **▼ TUNING ▲** on the front panel or hold down **◀** and **▶** on the remote control for 1 or 2 seconds, and the next station is searched for automatically.



- 5 Press **MEMORY/ENTER** on the remote control.

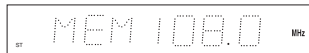

- 6 Repeat steps 2 to 5 to store other stations.

Radio Operation

Preset radio stations in the DVD+Hi-Fi VCR memory first (see "Presetting radio stations" on the left).

- 1 Press **FM/AM** on the remote control or on the front panel until the frequency band appears on the display and TV screen.

The last received station is tuned in.

- 2 Press **▲/▼** on the remote control repeatedly to select the preset station you want.

Each time you press the button, the DVD+Hi-Fi VCR tunes in one preset station at a time.

- 3 Adjust the sound level by rotating **VOLUME** on the front panel or by pressing **VOLUME +** or **-** on the remote control repeatedly.

To Clear Stored Radio Stations

- 1 Press **FM/AM** on the remote control or on the front panel until the frequency band appears on the display and TV screen.

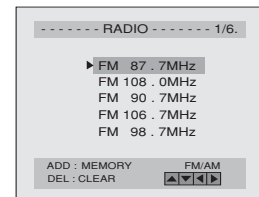

- 2 Use **▲/▼** on the remote control to select your desired station.

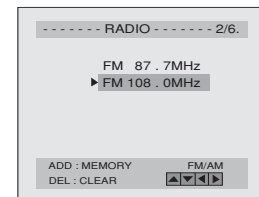

- 3 Press **CLEAR** the remote control to remove the stored radio station.

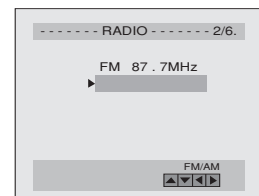

Note

- From Record or Record Pause mode, the **CLEAR** function is not available.

Radio Operation (Continued)

Tuning Stations Manually

- 1** Press FM/AM on the remote control or on the front panel until the frequency band appears on the display and TV screen.
- 2** Use FM/AM on the remote control or on the front panel to select the desired band.
- 3** Use ▼ TUNING ▲ on the front panel or press ◀ and ▶ on the remote control to tune in the desired station.

For your reference

FM Stereo

Press MONO/STEREO repeatedly on the front panel until "ST" appears in the display.

Weak FM stations

Press MONO/STEREO on the front panel until the "ST" word disappears from the display.

Background noise will be reduced but the signal reproduced will be mono.

To restore stereo reception, press MONO/STEREO on the front to select STEREO.

To turn the radio off

Press POWER to turn the DVD+Hi-Fi VCR off or select another function mode (CD/DVD, VCR, LINE 1 or LINE 2).

Tuning Stations Automatically

Hold down ▼ TUNING ▲ on the front panel or hold down ◀ and ▶ on the remote control for 1 or 2 seconds, and the next station is searched for automatically.

Note

- The search may not tune in or stop at a station with a very weak signal.

Mute

Press MUTE to remove the sound.

You can mute your unit in order, for example, to answer the telephone, "MUTE" indicator flashes in the display.

Press MUTE again to restore sound.

Troubleshooting

Check the following guide for the possible cause of a problem before contacting service.

Symptom	Cause	Correction
No power.	<ul style="list-style-type: none"> The power cord is disconnected. 	<ul style="list-style-type: none"> Plug the power cord into the wall outlet securely.
The power is on, but the DVD+Hi-Fi VCR does not work.	<ul style="list-style-type: none"> No disc is inserted. No tape is inserted. 	<ul style="list-style-type: none"> Insert a disc or tape. (Check that the disc or tape indicator in the display window is lit.)
No picture.	<ul style="list-style-type: none"> The TV is not set to receive DVD+Hi-Fi VCR signal output. 	<ul style="list-style-type: none"> Select the appropriate video input mode on the TV so the picture from the DVD+Hi-Fi VCR appears on the TV screen.
	<ul style="list-style-type: none"> TV/VCR mode for DVD+Hi-Fi VCR is set to TV. 	<ul style="list-style-type: none"> Press the TV/VCR button on the remote control repeatedly to choose VCR mode. TV indicator disappears from the display window.
	<ul style="list-style-type: none"> The video cable is not connected securely. 	<ul style="list-style-type: none"> Connect the video cable securely.
	<ul style="list-style-type: none"> The connected TV power is turned off. 	<ul style="list-style-type: none"> Turn on the TV.
No sound.	<ul style="list-style-type: none"> The Digital Audio Output is set to the wrong position. 	<ul style="list-style-type: none"> Set the Digital Audio Output to the correct position, then turn on the DVD+Hi-Fi VCR again by pressing POWER.
The playback picture is poor.	<ul style="list-style-type: none"> The disc is dirty. Tape heads are dirty. Tape is a rental or was recorded on another VCR. 	<ul style="list-style-type: none"> Clean the disc. Clean video heads. Use CH/TRK (▲/▼) for manual tracking adjustment while tape is playing.
The DVD+Hi-Fi VCR does not start playback.	<ul style="list-style-type: none"> No disc is inserted. No tape is inserted. 	<ul style="list-style-type: none"> Insert a disc or tape. (Check that the disc or tape indicator in the display window is lit.)
	<ul style="list-style-type: none"> An unplayable disc is inserted. 	<ul style="list-style-type: none"> Insert a playable disc. (Check the disc type, color system, and Regional code.)
	<ul style="list-style-type: none"> The disc is placed upside down. 	<ul style="list-style-type: none"> Place the disc with the playback side down.
	<ul style="list-style-type: none"> The disc is not placed within the guide. 	<ul style="list-style-type: none"> Place the disc on the disc tray correctly inside the guide.
	<ul style="list-style-type: none"> The disc is dirty. 	<ul style="list-style-type: none"> Clean the disc.
The remote control does not work properly.	<ul style="list-style-type: none"> The remote control is not pointed at the remote sensor of the DVD+Hi-Fi VCR. 	<ul style="list-style-type: none"> Point the remote control at the remote sensor of the DVD+Hi-Fi VCR.
	<ul style="list-style-type: none"> The remote control is too far from the DVD+Hi-Fi VCR. 	<ul style="list-style-type: none"> Operate the remote control within 23 ft (7 m).
	<ul style="list-style-type: none"> There is an obstacle in the path of the remote control and the DVD+Hi-Fi VCR. 	<ul style="list-style-type: none"> Remove the obstacle.
	<ul style="list-style-type: none"> The batteries in the remote control are exhausted. 	<ul style="list-style-type: none"> Replace the batteries with new ones.
	<ul style="list-style-type: none"> This remote control uses the same buttons for VCR and DVD functions (ex. PLAY). 	<ul style="list-style-type: none"> When using a VCR tape, first press the VCR button. When using a DVD, first press the DVD button.

Troubleshooting (Continued)

Symptom	Cause	Correction
Some channels are skipped over when using CH/TRK (▲/▼)	<ul style="list-style-type: none"> Those channels were deleted with the CH. ADD/DEL option. 	<ul style="list-style-type: none"> Use CH. ADD/DEL. to restore channels. See "Channel Selection" on page 17.
Picture and sound of broadcasting channel are weak or missing.	<ul style="list-style-type: none"> Antenna or cables are loose. 	<ul style="list-style-type: none"> Tighten connections or replace cable.
	<ul style="list-style-type: none"> Wrong TUNING BAND option is being used. 	<ul style="list-style-type: none"> Try all TUNING BAND options. See "Channel Selection" on page 17 for details.
Camcorder image is not shown.	<ul style="list-style-type: none"> Camcorder is off. 	<ul style="list-style-type: none"> Turn camcorder on and operate properly.
Camcorder image via A/V input to DVD+Hi-Fi VCR is not shown on TV screen.	<ul style="list-style-type: none"> DVD+Hi-Fi VCR SOURCE SELECT is not set to LINE1 or LINE2. 	<ul style="list-style-type: none"> Use INPUT to select LINE input source (LINE1 or LINE2).
Timer recording is not possible.	<ul style="list-style-type: none"> Clock in DVD+Hi-Fi VCR is not set to correct time. 	<ul style="list-style-type: none"> Set clock to correct time. See "Setting the Clock" on page 18.
	<ul style="list-style-type: none"> Timer has been programmed incorrectly. 	<ul style="list-style-type: none"> Reprogram Timer. See "Timer Recording" on pages 24 and 25.
	<ul style="list-style-type: none"> Ⓢ indicator does not appear after programming timer. 	<ul style="list-style-type: none"> Reprogram Timer.
Ⓢ indicator appears after DVD+Hi-Fi VCR is turned off.	<ul style="list-style-type: none"> DVD+Hi-Fi VCR is in Timer Recording mode. 	<ul style="list-style-type: none"> This is the normal indication that the DVD+Hi-Fi VCR is in TIMER mode.
Stereo Audio Record and/or Playback is not present.	<ul style="list-style-type: none"> TV is not Stereo-compatible. 	<ul style="list-style-type: none"> No action is possible.
	<ul style="list-style-type: none"> Broadcast program is not in stereo format. 	<ul style="list-style-type: none"> No action is possible.
	<ul style="list-style-type: none"> DVD+Hi-Fi VCR BROADCAST TYPE mode is set to SAP or MONO. 	<ul style="list-style-type: none"> Set BROADCAST TYPE mode to STEREO. See "Setting the VCR Setup Menu" on page 17.

Moisture Condensation

Moisture condensation can occur:	In locations where moisture condensation may occur:
<ul style="list-style-type: none"> When the DVD+Hi-Fi VCR is moved from a cold place to a warm place. Under extremely humid conditions. 	<ul style="list-style-type: none"> Keep the DVD+Hi-Fi VCR plugged into an AC power outlet with POWER On. This will help prevent condensation. When condensation has occurred, wait a few hours for the DVD+Hi-Fi VCR to dry before using it.

Language Code List

DVD+Hi-Fi VCR memory/enter the appropriate code number for the initial settings "Disc Audio", "Disc Subtitle" and/or "Disc Menu" (See page 20).

Language	Code	Language	Code	Language	Code	Language	Code
Abkhazian	6566	Fiji	7074	Lingala	7678	Singhalese	8373
Afar	6565	Finnish	7073	Lithuanian	7684	Slovak	8375
Afrikaans	6570	French	7082	Macedonian	7775	Slovenian	8376
Albanian	8381	Frisian	7089	Malagasy	7771	Somali	8379
Amharic	6577	Galician	7176	Malay	7783	Spanish	6983
Arabic	6582	Georgian	7565	Malayalam	7776	Sudanese	8385
Armenian	7289	German	6869	Maltese	7784	Swahili	8387
Assamese	6583	Greek	6976	Maori	7773	Swedish	8386
Aymara	6588	Greenlandic	7576	Marathi	7782	Tagalog	8476
Azerbaijani	6590	Guarani	7178	Moldavian	7779	Tajik	8471
Bashkir	6665	Gujarati	7185	Mongolian	7778	Tamil	8465
Basque	6985	Hausa	7265	Nauru	7865	Tatar	8484
Bengali; Bangla	6678	Hebrew	7387	Nepali	7869	Telugu	8469
Bhutani	6890	Hindi	7273	Norwegian	7879	Thai	8472
Bihari	6672	Hungarian	7285	Oriya	7982	Tibetan	6679
Breton	6682	Icelandic	7383	Panjabi	8065	Tigrinya	8473
Bulgarian	6671	Indonesian	7378	Pashto, Pushto	8083	Tonga	8479
Burmese	7789	Interlingua	7365	Persian	7065	Turkish	8482
Byelorussian	6669	Irish	7165	Polish	8076	Turkmen	8475
Cambodian	7577	Italian	7384	Portuguese	8084	Twi	8487
Catalan	6765	Japanese	7465	Quechua	8185	Ukrainian	8575
Chinese	9072	Javanese	7487	Rhaeto-Romance	8277	Urdu	8582
Corsican	6779	Kannada	7578	Romanian	8279	Uzbek	8590
Croatian	7282	Kashmiri	7583	Russian	8285	Vietnamese	8673
Czech	6783	Kazakh	7575	Samoan	8377	Volapük	8679
Danish	6865	Kirghiz	7589	Sanskrit	8365	Welsh	6789
Dutch	7876	Korean	7579	Scots Gaelic	7168	Wolof	8779
English	6978	Kurdish	7585	Serbian	8382	Xhosa	8872
Esperanto	6979	Laothian	7679	Serbo-Croatian	8372	Yiddish	7473
Estonian	6984	Latin	7665	Shona	8378	Yoruba	8979
Faeroese	7079	Latvian, Lettish	7686	Sindhi	8368	Zulu	9085

Country Code List

DVD+Hi-Fi VCR memory/enter the appropriate code number for the initial setting "Country Code" (See page 22).

Code	Country	Code	Country	Code	Country	Code	Country
AD	Andorra	ER	Eritrea	LC	Saint Lucia	SC	Seychelles
AE	United Arab Emirates	ES	Spain	LI	Liechtenstein	SD	Sudan
AF	Afghanistan	ET	Ethiopia	LK	Sri Lanka	SE	Sweden
AG	Antigua and Barbuda	FI	Finland	LR	Liberia	SG	Singapore
AI	Anguilla	FJ	Fiji	LS	Lesotho	SH	Saint Helena
AL	Albania	FK	Falkland Islands	LT	Lithuania	SI	Slovenia
AM	Armenia	FM	Micronesia	LU	Luxembourg	SJ	Svalbard and Jan Mayen Islands
AN	Netherlands Antilles	FO	Faroe Islands	LV	Latvia	SK	Slovak Republic
AO	Angola	FR	France	LY	Libya	SL	Sierra Leone
AQ	Antarctica	FX	France (European Territory)	MA	Morocco	SM	San Marino
AR	Argentina	GA	Gabon	MC	Monaco	SN	Senegal
AS	American Samoa	GB	Great Britain	MD	Moldavia	SO	Somalia
AT	Austria	GD	Grenada	MG	Madagascar	SR	Suriname
AU	Australia	GE	Georgia	MH	Marshall Islands	ST	Saint Tome and Principe
AW	Aruba	GF	French Guyana	MK	Macedonia	SU	Former USSR
AZ	Azerbaijan	GH	Ghana	ML	Mali	SV	El Salvador
BA	Bosnia-Herzegovina	GI	Gibraltar	MM	Myanmar	SY	Syria
BB	Barbados	GL	Greenland	MN	Mongolia	SZ	Swaziland
BD	Bangladesh	GM	Gambia	MO	Macau	TC	Turks and Caicos Islands
BE	Belgium	GN	Guinea	MP	Northern Mariana Islands	TD	Chad
BF	Burkina Faso	GP	Guadeloupe (French)	MQ	Martinique (French)	TF	French Southern Territories
BG	Bulgaria	GQ	Equatorial Guinea	MR	Mauritania	TG	Togo
BH	Bahrain	GR	Greece	MS	Montserrat	TH	Thailand
BI	Burundi	GS	S. Georgia & S. Sandwich Isls.	MT	Malta	TJ	Tadjikistan
BJ	Benin	GT	Guatemala	MU	Mauritius	TK	Tokelau
BM	Bermuda	GU	Guam (USA)	MV	Maldives	TM	Turkmenistan
BN	Brunei Darussalam	GW	Guinea Bissau	MW	Malawi	TN	Tunisia
BO	Bolivia	GY	Guyana	MX	Mexico	TO	Tonga
BR	Brazil	HK	Hong Kong	MY	Malaysia	TP	East Timor
BS	Bahamas	HM	Heard and McDonald Islands	MZ	Mozambique	TR	Turkey
BT	Bhutan	HN	Honduras	NA	Namibia	TT	Trinidad and Tobago
BV	Bouvet Island	HR	Croatia	NC	New Caledonia (French)	TV	Tuvalu
BW	Botswana	HT	Haiti	NE	Niger	TW	Taiwan
BY	Belarus	HU	Hungary	NF	Norfolk Island	TZ	Tanzania
BZ	Belize	ID	Indonesia	NG	Nigeria	UA	Ukraine
CA	Canada	IE	Ireland	NI	Nicaragua	UG	Uganda
CC	Cocos (Keeling) Islands	IL	Israel	NL	Netherlands	UK	United Kingdom
CF	Central African Republic	IN	India	NO	Norway	UM	USA Minor Outlying Islands
CG	Congo	IO	British Indian Ocean Territory	NP	Nepal	US	United States
CH	Switzerland	IQ	Iraq	NR	Nauru	UY	Uruguay
CI	Ivory Coast	IR	Iran	NU	Niue	UZ	Uzbekistan
CK	Cook Islands	IS	Iceland	NZ	New Zealand	VA	Vatican City State
CL	Chile	IT	Italy	OM	Oman	VC	Saint Vincent & Grenadines
CM	Cameroon	JM	Jamaica	PA	Panama	VE	Venezuela
CN	China	JO	Jordan	PE	Peru	VG	Virgin Islands (British)
CO	Colombia	JP	Japan	PF	Polynesia (French)	VI	Virgin Islands (USA)
CR	Costa Rica	KE	Kenya	PG	Papua New Guinea	VN	Vietnam
CS	Former Czechoslovakia	KG	Kyrgyzstan	PH	Philippines	VU	Vanuatu
CU	Cuba	KH	Cambodia	PK	Pakistan	WF	Wallis and Futuna Islands
CV	Cape Verde	KI	Kiribati	PL	Poland	WS	Samoa
CX	Christmas Island	KM	Comoros	PM	Saint Pierre and Miquelon	YE	Yemen
CY	Cyprus	KN	Saint Kitts & Nevis Anguilla	PN	Pitcairn Island	YT	Mayotte
CZ	Czech Republic	KP	North Korea	PR	Puerto Rico	YU	Yugoslavia
DE	Germany	KR	South Korea	PT	Portugal	ZA	South Africa
DJ	Djibouti	KW	Kuwait	PW	Palau	ZM	Zambia
DK	Denmark	KY	Cayman Islands	PY	Paraguay	ZR	Zaire
DM	Dominica	KZ	Kazakhstan	QA	Qatar	ZW	Zimbabwe
DO	Dominican Republic	LA	Laos	RE	Reunion (French)		
DZ	Algeria	LB	Lebanon	RO	Romania		
EC	Ecuador			RU	Russian Federation		
EE	Estonia			RW	Rwanda		
EG	Egypt			SA	Saudi Arabia		
EH	Western Sahara			SB	Solomon Islands		

Specifications

General

Power requirements	AC 120V, 60 Hz
Power consumption	130W
Dimensions (approx.)	430 X 90 X 350 mm (16.9 x 3.5 x 13.8 inches) (w x h x d)
Weight (approx.)	8 kg (17.6 lbs)
Operating temperature	5°C to 40°C (41°F to 104°F)
Operating humidity	5 % to 90 %
Signal system	NTSC

Inputs

ANTENNA IN	Antenna or CATV input, 75 ohms
VHS VIDEO IN(LINE1, 2)	1 Vp-p 75 ohms, sync negative, RCA jack x 2
VHS AUDIO IN(LINE1, 2)	-6.0 dBm more than 47 ohms, RCA jack (L, R) x 2

Outputs

MONITOR OUT	1 Vp-p 75 ohms, sync negative
S-VIDEO OUT	(Y) 1.0 V (p-p), 75 ohms, negative sync, Mini DIN 4-pin x 1 (C) 0.3 V (p-p) 75 ohms
Component Video output	(Y) 1.0 V (p-p), 75 Ω, negative sync., RCA jack x 1 (Pb)/(Pr) 0.7 V (p-p), 75 Ω, RCA jack x 1

VCR Specifications

Head system	Four head helical scan azimuth system
Timer	12-hour display type with AM, PM
Tape speed	SP: 33.35 mm/sec, LP: 16.67 mm/sec, SLP: 11.12 mm/sec
Tape width	12.7 mm
Maximum recording time	SP: 2 HOURS (T-120), SLP: 6 HOURS (T-120)/8 HOURS (T-160)
Rewind time	About 3 minutes (T-120)
Antenna	75 ohms (VHF/UHF)
VHF output signal	Channel 3 or 4
Channel coverage	VHF: 2-13, UHF: 14-69, CATV: 1-125 (4A, A-W, W+1 - W+84, A-5 - A-1)
Frequency range	200Hz to 8kHz
Signal-to-noise ratio	More than 65 dB (EE mode)
Dynamic range	More than 70 dB (EE mode)
Channel separation	More than 45 dB (EE mode)

DVD Specifications

Laser system	Semiconductor laser, wavelength 650 nm
Frequency response	DVD (PCM 96 kHz): 8 Hz to 44 kHz, DVD (PCM 48 kHz): 8 Hz to 22 kHz CD: 200 Hz to 18 kHz
Signal-to-noise ratio	More than 70 dB
Harmonic distortion	Less than 0.5 %
Dynamic range	More than 65 dB (DVD/CD)

Tuner section

System	PLL quartz-locked digital synthesizer system
Tuning range	87.5 ~ 108.0 MHz (FM) 530 ~ 1720 KHz (AM)
Antenna	Wire antenna (FM) Loop antenna (AM)

Specifications (Continued)

Speakers

Satellite (LHS-C6237T)

Type	1 Way 1 Speaker
Impedance	4 Ω
Frequency Response	130 - 20,000 Hz
Sound Pressure Level	83 dB/W (1m)
Rated Input Power	20W
Max Input Power	40W
Net Dimensions (W x H x D)	88 x 100 x 95 mm
Net Weight	0.54 kg

Passive Subwoofer (LHS-C6237W)

Type	1 Way 1 Speaker
Impedance	8 Ω
Frequency Response	50 - 1,500 Hz
Sound Pressure Level	82 dB/W (1m)
Rated Input Power	40W
Max Input Power	80W
Net Dimensions (W x H x D)	160 x 350 x 325 mm
Net Weight	4.12 kg

Accessories:

Video cable x 1, RF 75-ohm Coaxial Cable x 1, Speaker cable x 5, FM Antenna cable x 1, AM Antenna cable x 1, Remote control x 1, Batteries (AAA) x 2

- Design and specifications are subject to change without prior notice.

Notes

Notes

Notes

**ZENITH ELECTRONICS CORPORATION
DVD+Hi-Fi VCR Combo Home Theater System XBS341
LIMITED WARRANTY – USA**

Zenith will repair or replace your product, at Zenith's option, if it proves to be defective in material or workmanship under normal use, during the warranty period ("Warranty Period") listed below, effective from the date ("Date of Purchase") of original purchase of the product. This limited warranty is good only to the original purchaser of the product and effective only when used in the United States, excluding U.S. Territories.

<p>WARRANTY PERIOD:</p> <p>LABOR: 90 days from the Date of Purchase.</p> <p>PARTS: 1 Year from the Date of Purchase.</p> <p>* Parts replaced are warranted for the remaining portion of the original warranty period.</p>	<p>HOW SERVICE IS HANDLED:</p> <p>Carry-In Service: Please retain dealer's dated bill of sale or delivery ticket as evidence of the Date of Purchase for proof of warranty, and submit a copy of the bill of sale to the service person at the time warranty service is provided.</p> <p>Please call 1-877-9Zenith (1-877-993-6484) to locate your nearest Zenith Authorized Service Center.</p> <p>Or visit our website at http://www.zenithservice.com</p>
--	--

THIS WARRANTY IS IN LIEU OF ANY OTHER WARRANTY, EXPRESS OR IMPLIED, INCLUDING WITHOUT LIMITATION, ANY WARRANTY OF MERCHANTABILITY OR FITNESS FOR A PARTICULAR PURPOSE. TO THE EXTENT ANY IMPLIED WARRANTY IS REQUIRED BY LAW, IT IS LIMITED IN DURATION TO THE EXPRESS WARRANTY PERIOD ABOVE. ZENITH WILL NOT BE LIABLE FOR ANY INCIDENTAL, CONSEQUENTIAL, INDIRECT, SPECIAL, OR PUNITIVE DAMAGES OF ANY NATURE, EVEN IF ADVISED OF THE POSSIBILITY OF SUCH DAMAGES, INCLUDING WITHOUT LIMITATION, LOST REVENUES OR PROFITS, LOST OR CORRUPTED PROGRAMMING OR DATA, OR ANY OTHER DAMAGE WHETHER BASED IN CONTRACT, TORT, OR OTHERWISE.

Some states do not allow the exclusion or limitation of incidental or consequential damages or limitations on how long an implied warranty lasts, so the above exclusion or limitation may not apply to you. This warranty gives you specific legal rights and you may also have other rights that vary from state to state.

THIS LIMITED WARRANTY DOES NOT APPLY TO:

- Damage caused in shipping or transit
- Service required as a result of improper installation, including incorrect or insufficient AC supply (Please consult the owner's manual for power supply requirements)
- Installation or repair of other components in a video system
- Set-up or adjustment on consumer controls, or damage caused by improper adjustments
- Damage cause by other system components
- Damage (including cosmetic damage), failure, loss or personal injury due to misuse, abuse, negligence, improper maintenance or storage, or to acts of nature or other causes beyond Zenith's control (Causes beyond Zenith's control include but are not limited to lightning strike, power surges, power outages, and water damage)
- Repair or replacement of warranted parts by other than Zenith Authorized Service Centers
- Units purchased or serviced outside the coverage area
- Product where the original factory serial numbers have been removed, defaced, or changed in any way
- Product sold and labeled as "as is, where is" or similar disclaimer

The costs of repair or replacement under these excluded circumstances shall be borne by the consumer.

CUSTOMER INTER-ACTIVE CENTER NUMBERS:

<p>For nearest Authorized Service Center, Where to buy, Product Assistance, or Customer Assistance</p>	<p>Call 1-877-9Zenith (1-877-993-6484) (Monday ~ Friday, 7 AM ~ 8 PM CT; and Saturday, 8 AM ~ 5 PM CT) and select appropriate option from the menu.</p> <p>Or visit our website at http://www.zenithservice.com</p>
---	---

ZENITH ELECTRONICS CORPORATION
2000 MILLBROOK DRIVE
LINCOLNSHIRE, IL 60069

Zenith Part No. 206-03872
GS# 3828R-D032C
Printed in Indonesia
Issue O